



# Insight™ Lawn Mower

Model No. 10682—Serial No. 26000001 and Up

## Operator's Manual

# Introduction

Read this information carefully to learn how to operate and maintain your product properly and to avoid injury and product damage. You are responsible for operating the product properly and safely.

You may contact Lawn-Boy directly at [www.Lawn-Boy.com](http://www.Lawn-Boy.com) for product and accessory information, help finding a dealer, or to register your product.

Whenever you need service, genuine Lawn-Boy parts, or additional information, contact an Authorized Service Dealer or Lawn-Boy Customer Service and have the model and serial numbers of your product ready. Figure 1 identifies the location of the model and serial numbers on the product. Write the numbers in the space provided.

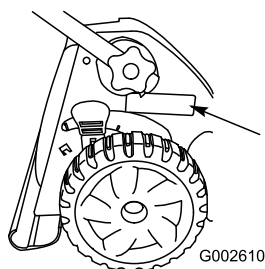

**Figure 1**

- 1. Model and serial number plate

<b>Model No.</b> _____
<b>Serial No.</b> _____

This manual identifies potential hazards and has safety messages identified by the safety alert symbol (Figure 2), which signals a hazard that may cause serious injury or death if you do not follow the recommended precautions.



**Figure 2**

- 1. Safety alert symbol

This manual uses two words to highlight information.

**Important** calls attention to special mechanical information and **Note** emphasizes general information worthy of special attention.

## Warning

### CALIFORNIA Proposition 65 Warning

The engine exhaust from this product contains chemicals known to the State of California to cause cancer, birth defects, or other reproductive harm.

**Important:** This engine is not equipped with a spark arrester muffler. It is a violation of California Public Resource Code Section 4442 to use or operate the engine on any forest-covered, brush-covered, or grass-covered land. Other states or federal areas may have similar laws.

This spark ignition system complies with Canadian ICES-002

The enclosed Engine Owner's Manual is supplied for information regarding the US Environmental Protection Agency (EPA) and the California Emission Control Regulation of emission systems, maintenance, and warranty. Replacements may be ordered through the engine manufacturer.

For models with stated engine horsepower, the gross horsepower of the engine was laboratory rated by the engine manufacturer in accordance with SAE J1940. As configured to meet safety, emission, and operating requirements, the actual engine horsepower on this class of lawn mower will be significantly lower.

Do not tamper with the engine controls or alter the governor speed; doing so may create an unsafe condition resulting in personal injury.

# Safety

This lawn mower meets or exceeds the CPSC blade safety requirements for walk-behind rotary lawn mowers and the B71.1 specifications of the American National Standards Institute in effect at the time of production.

**Read and understand the contents of this manual before you start the engine.**

The safety alert symbol (Figure 2) is used to alert you to potential personal injury hazards. Obey all safety messages that follow this symbol to avoid possible injury or death. Improperly using or maintaining this mower could result in

injury or death. To reduce this potential, comply with the following safety instructions.

The following instructions have been adapted from the ANSI/OPEI standard B71.1-2003.

**This cutting machine is capable of amputating hands and feet and of throwing objects. Failure to observe the following safety instructions could result in serious injury or death.**

## General Operation

- Read, understand, and follow all instructions on the machine and in the manual(s) before starting.
- Do not put hands or feet near or under the machine. Keep clear of the discharge opening at all times.
- Only allow responsible adults, who are familiar with the instructions, to operate this machine.
- Clear the area of objects such as rocks, wire, toys, etc., which could be thrown by the blade. Stay behind the handle when the engine is running.
- Be sure the area is clear of bystanders before operating. Stop machine if anyone enters the area.
- Do not operate machine barefooted or while wearing sandals. Always wear substantial footwear.
- Do not pull machine backward unless absolutely necessary. Always look down and behind before and while moving backward.
- Never direct discharged material toward anyone. Avoid discharging material against a wall or obstruction. Material may ricochet back toward the operator. Stop the blade when crossing gravel surfaces.
- Do not operate machine without the entire grass catcher, discharge guard, rear guard, or other safety protective devices in place and working.
- Never leave a running machine unattended.
- Stop the engine and wait until the blade comes to a complete stop before cleaning the machine, removing grass catcher, or unclogging the discharge guard.
- Operate machine only in daylight or good artificial light.
- Do not operate machine while under the influence of alcohol or drugs.
- Never operate mower in wet grass. Always be sure of your footing; walk; never run.
- Disengage the drive system, if so equipped, before starting the engine.
- If the machine should start to vibrate abnormally, stop the engine and check for the cause immediately. Vibration is generally a warning of trouble.

- Always wear eye protection when operating machine.
- See manufacturer's instructions for proper operation and installation of accessories. Only use accessories approved by the manufacturer.

## Slope Operation

Slopes are a major factor related to slip and fall accidents, which can result in severe injury. Operation on all slopes require extra caution. If you feel uneasy on a slope, do not mow it.

- Mow across the face of slopes; never up and down. Exercise extreme caution when changing direction on slopes.
- Watch for holes, ruts, bumps, rocks, or other hidden objects. Uneven terrain could cause a slip and fall accident. Tall grass can hide obstacles.
- Do not mow on wet grass or excessively steep slopes. Poor footing could cause a slip and fall accident.
- Do not mow near drop-offs, ditches, or embankments. You could lose your footing or balance.

## Children

Tragic accidents can occur if the operator is not alert to the presence of children. Children are often attracted to the machine and the mowing activity. **Never** assume that children will remain where you last saw them.

- Keep children out of the mowing area and under the watchful care of a responsible adult other than the operator.
- Be alert and turn mower off if a child enters the area.
- Never allow children to operate the machine.
- Use extra care when approaching blind corners, shrubs, trees, or other objects that may block your view of a child.

## Service

### Safe Handling of Gasoline

**To avoid personal injury or property damage, use extreme care in handling gasoline. Gasoline is extremely flammable and the vapors are explosive.**

- Extinguish all cigarettes, cigars, pipes, and other sources of ignition.
- Use only an approved gasoline container.
- Never remove gas cap or add fuel with the engine running. Allow engine to cool before refueling.
- Never refuel the machine indoors.
- Never store the machine or fuel container where there is an open flame, spark, or pilot light such as on a water heater or on other appliances.

- Never fill containers inside a vehicle or on a truck or trailer bed with a plastic liner. Always place containers on the ground away from your vehicle before filling.
- Remove gas-powered equipment from the truck or trailer and refuel it on the ground. If this is not possible, then refuel such equipment with a portable container, rather than from a gasoline dispenser nozzle.
- Keep the nozzle in contact with the rim of the fuel tank or container opening at all times until fueling is complete. Do not use a nozzle lock-open device.
- If fuel is spilled on clothing, change clothing immediately.
- Never overfill fuel tank. Replace gas cap and tighten securely.



**Exhaust contains carbon monoxide, an odorless, deadly poison that can kill you.**

**Do not run the engine indoors or in an enclosed area.**

### General Service

- Never operate machine in a closed area.
- Keep all nuts and bolts tight to be sure the equipment is in safe working condition.
- Never tamper with safety devices. Check their proper operation regularly.
- Keep machine free of grass, leaves, or other debris build-up. Clean up oil or fuel spillage and remove any fuel-soaked debris. Allow machine to cool before storing.
- If you strike a foreign object, stop and inspect the machine. Repair, if necessary, before starting.
- Never make any adjustments or repairs with the engine running. Disconnect the spark plug wire and ground against engine to prevent unintended starting.
- Check grass catcher components and the discharge guard frequently and replace with manufacturer's recommended parts, when necessary.
- Mower blades are sharp. Wrap the blade or wear gloves, and use extra caution when servicing them.
- Do not change the engine governor setting or overspeed the engine.
- Maintain or replace safety and instruction labels, as necessary.

## Safety and Instructional Decals

**Important:** Safety and instruction decals are located near areas of potential danger. Replace damaged decals.



**94-8072**



**107-1938**



**107-3888**



**107-3889**

1. Do not operate the mower without the rear discharge plug or bag in place; do not operate the mower without the side discharge cover or deflector in place.



**108-7450**

1. Height of cut

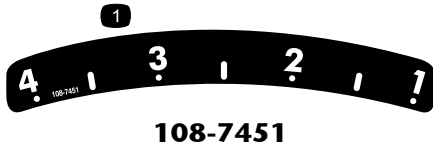

1. Height of cut

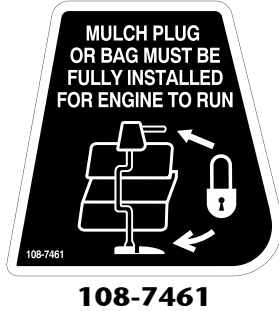

108-7461

## Setup

**Important:** Remove and discard the protective plastic sheet that covers the engine.

### 1. Unfolding the Handle



Folding or unfolding the handle improperly can damage the cables, causing an unsafe operating condition.

- Do not damage the cables when folding or unfolding the handle.
- If a cable is damaged, contact an Authorized Service Dealer.

1. Unfold the handle as illustrated in Figure 3 and Figure 4.

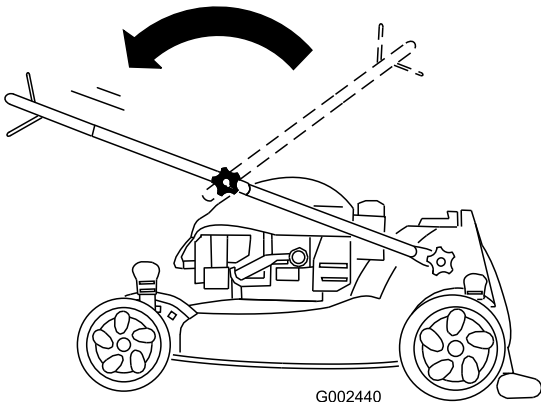

Figure 3

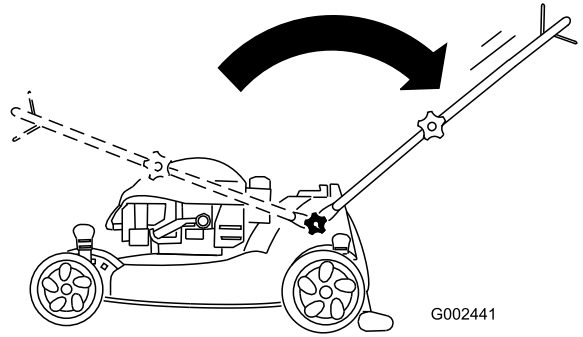

Figure 4

2. Tighten the 4 handle knobs.

### 2. Filling the Engine with Oil

Your mower does not come with oil in the engine, but it does come with a bottle of oil.

1. Remove the dipstick (Figure 5).

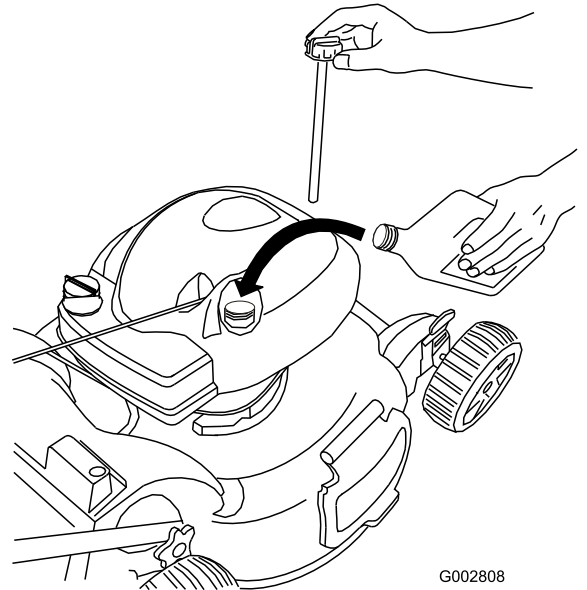
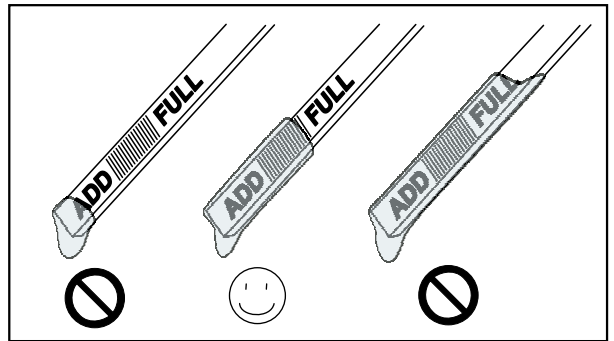

Figure 5

2. **Slowly** pour oil into the oil fill tube until the oil level reaches the **Full** line on the dipstick (Figure 5). **Do not overfill.** (Max. fill: 20 oz., type: SAE 30W detergent oil with an API service classification of SF, SG, SH, SJ, SL, or higher.)

**Note:** If you overfill the engine, pour some oil out of it as directed in Changing the Engine Oil.

3. Install the dipstick securely.

**Important:** Change the engine oil after the first 2 operating hours; change it yearly thereafter. Refer to Changing the Engine Oil.

### 3. Install the Mulch Plug or Grass Bag

You must correctly install the mulch plug (for mulching or side-discharging) or grass bag (for bagging) or **the engine will not start.**

The mower has a safety switch, located at the bottom of a channel on the top, right rear of the mower, that prevents the mower from operating without a mulch plug or grass bag. This prevents the mower from throwing debris at the operator through the rear chute.

For the switch to detect the presence of the mulch plug, the top of the mulch plug lever must **lie fully** in the **bottom of the channel** and the bottom of the lever must **latch securely** in the **lever retaining clip** at the bottom of the mower (Figure 6).

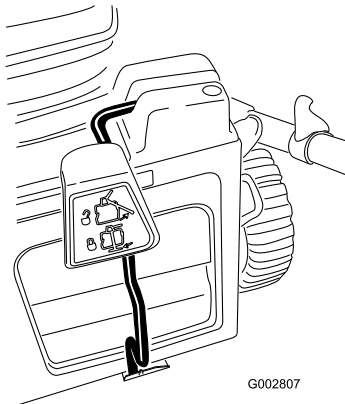

**Figure 6**

1. Switch channel
  2. Mulch plug lever
  3. Lever retaining clip
1. Insert the mulch plug into the mower, if it isn't already installed (Figure 7).

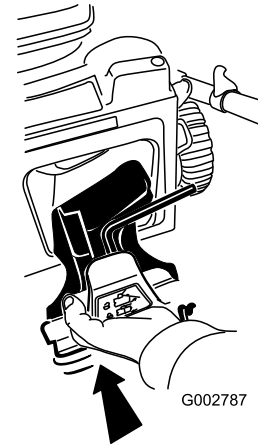

**Figure 7**

2. Swing the lever into the switch channel and lever retainer (Figure 8).

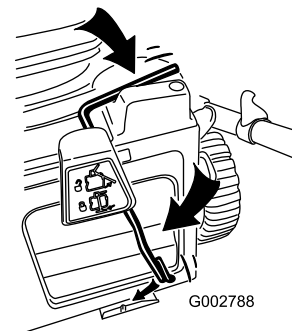

**Figure 8**

3. Ensure that the lever snaps snugly into place in both the switch channel and lever retainer (Figure 9). **If they do not, your mower will not start!**

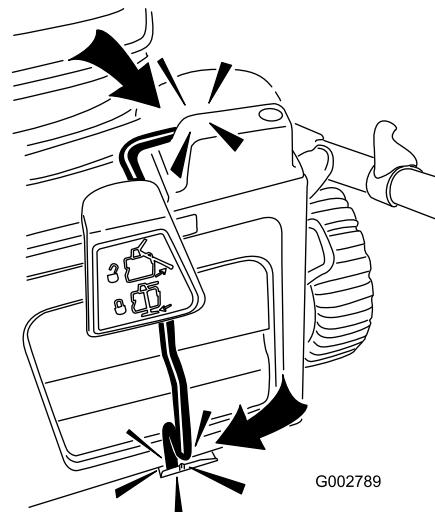

**Figure 9**

# Product Overview

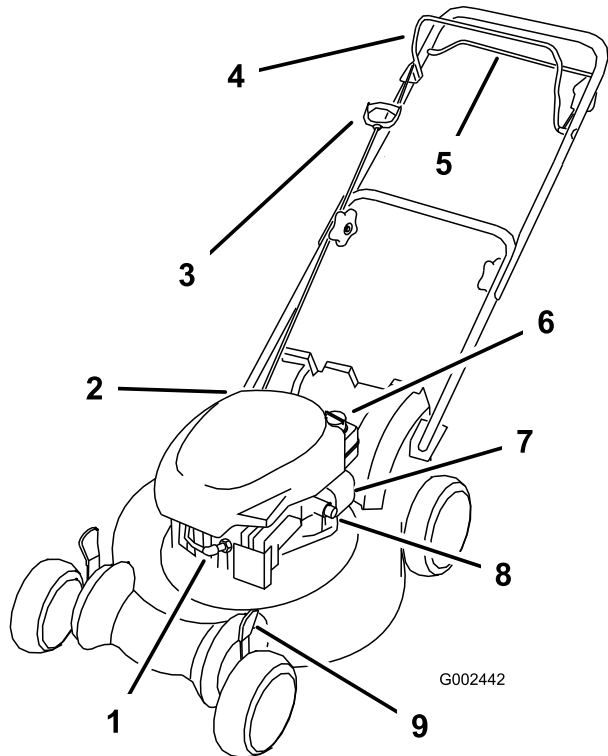

**Figure 10**

- |                                  |                         |
|----------------------------------|-------------------------|
| 1. Spark plug                    | 6. Fuel tank cap        |
| 2. Oil fill/Dipstick (not shown) | 7. Air filter           |
| 3. Recoil start handle           | 8. Primer               |
| 4. Blade control bar             | 9. Cutting height lever |
| 5. Self-propel drive bar         |                         |

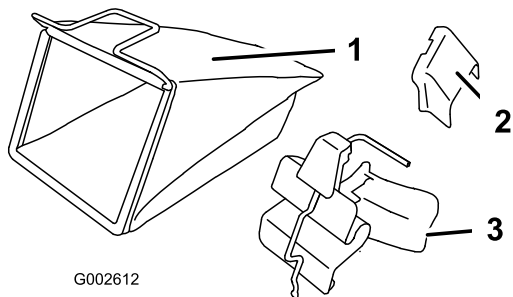

**Figure 11**

- |                         |                           |
|-------------------------|---------------------------|
| 1. Grass bag            | 3. Mulch plug (installed) |
| 2. Side discharge chute |                           |

# Operation

## Filling the Fuel Tank



Gasoline is extremely flammable and explosive. A fire or explosion from gasoline can burn you and others.

- To prevent a static charge from igniting the gasoline, place the container and/or mower directly on the ground before filling, not in a vehicle or on an object.
- Fill the tank outdoors when the engine is cold. Wipe up spills.
- Do not handle gasoline when smoking or around an open flame or sparks.
- Store gasoline in an approved fuel container, out of the reach of children.

Fill the fuel tank with fresh unleaded regular gasoline from a major name-brand service station (Figure 12).

**Important:** To reduce starting problems, add fuel stabilizer to the fuel all season, mixing it with gasoline less than 30 days old.

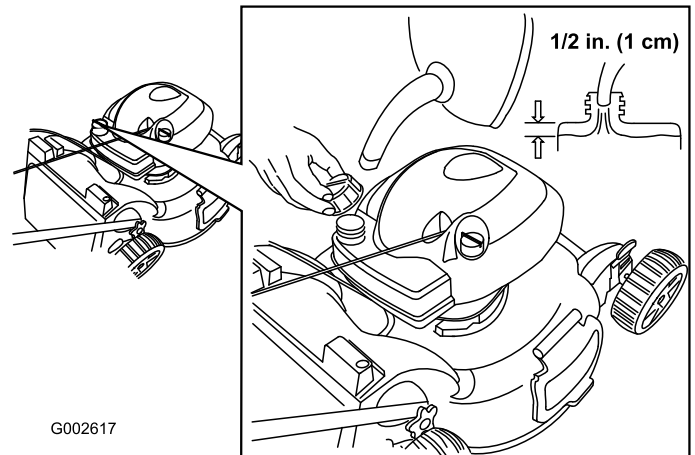

**Figure 12**

## Checking the Engine Oil Level

1. Remove the dipstick, wipe it clean, and fully install the dipstick (Figure 13).

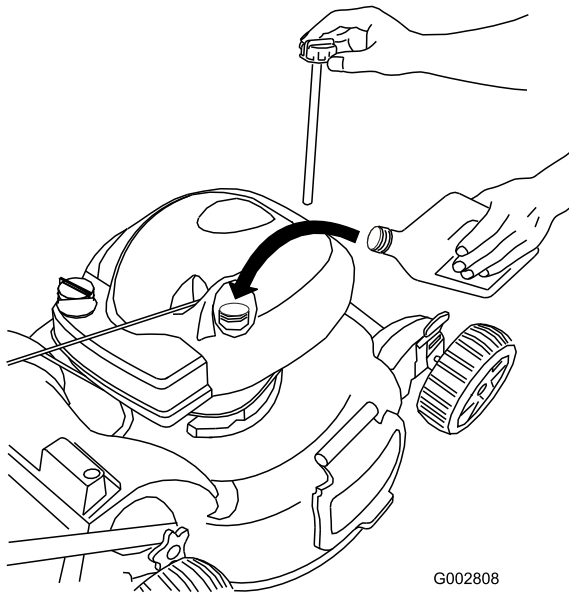
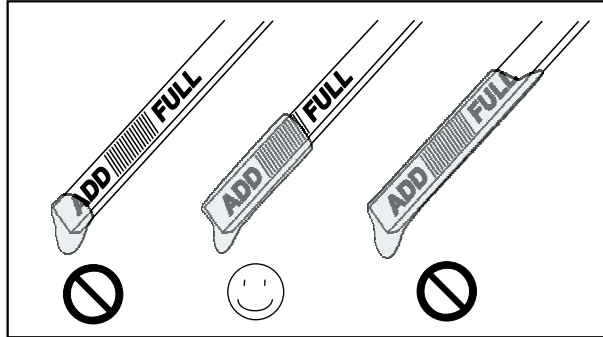

**Figure 13**

2. Remove the dipstick and check the oil level (Figure 13). If the oil level is below the **Add** mark on the dipstick, slowly pour oil into the oil fill tube to raise the oil level to the **Full** mark on the dipstick. **Do not overfill.** (Max. fill: 20 oz., type: SAE 30W detergent oil with an API service classification of SF, SG, SH, SJ, SL, or higher.)

**Note:** If you overfill the engine, pour some oil out of it as directed in Changing the Engine Oil.

3. Install the dipstick.

## Adjusting the Cutting Height



Adjusting the cutting height may bring you into contact with the moving blade, causing serious injury.

- Stop the engine and wait for all moving parts to stop.
- Do not put your fingers under the housing when adjusting the cutting height.



If the engine has been running, the muffler will be hot and can severely burn you. Keep away from the hot muffler.

Adjust the cutting height as desired. Set all four wheels to the same height.

**Note:** To raise the mower, move the front cutting height levers forward and the rear cutting height levers rearward; to lower the mower, move the front levers rearward and the rear levers forward.

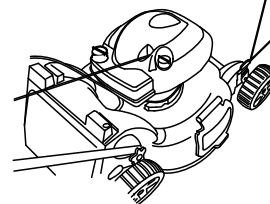
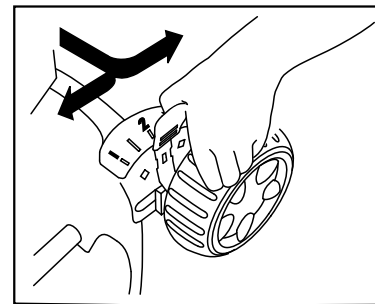

**Figure 14**

## Starting the Engine

1. Firmly push in the primer 3 times with your thumb, holding the primer in for a second before releasing it each time (Figure 15).

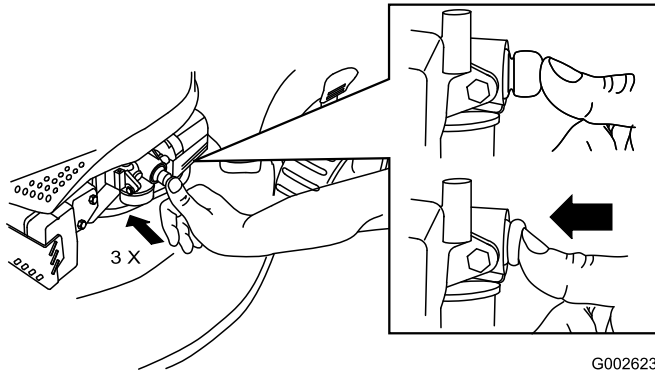

**Figure 15**

**Note:** If the air temperature is below 55°F (13°C), firmly push the primer in 5 times.

2. Hold the blade control bar (Figure 16) against the handle.

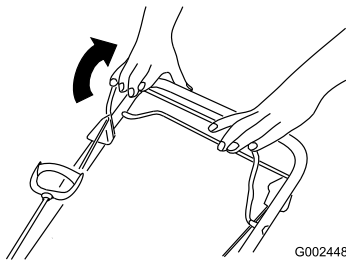

**Figure 16**

1. Blade control bar

3. Start the engine using the recoil starter (Figure 17).

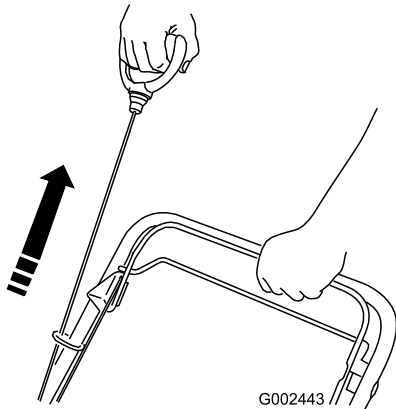

**Figure 17**

4. If the mower does not start in 1 or 2 pulls, press the primer button 1 or 2 times and try starting it again.

**Note:** If the mower still does not start, contact an Authorized Service Dealer.

## Using the Self-propel Drive

To operate the self-propel drive, squeeze the self-propel drive bar (Figure 18) toward the handle and hold it.

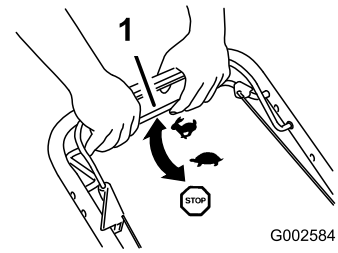

**Figure 18**

1. Self-propel drive bar

To disengage the self-propel drive, release the self-propel drive bar.

**Note:** The maximum self-propel ground speed is fixed. To reduce the ground speed, increase the space between the self-propel drive bar and the handle.

## Stopping the Engine

To stop the engine, release the blade control bar (Figure 19).

**Important:** When you release the blade control bar, both the engine and blade should stop within 3 seconds. If they do not stop properly, stop using your mower immediately and contact an Authorized Service Dealer.

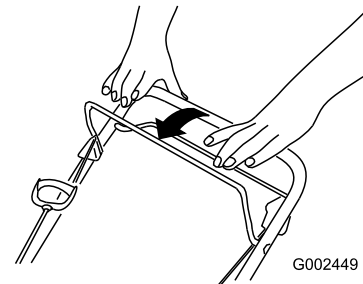

**Figure 19**

## Mulching the Clippings

Your mower comes from the factory ready to mulch the grass and leaf clippings back into the lawn.

If the grass bag is on the mower, remove it (refer to Removing the Grass Bag) before mulching the clippings. If the side discharge chute is on the mower, remove it and lock the side discharge door (refer to Removing the Side Discharge Chute) before mulching the clippings.

**Important:** The mower has a safety switch that prevents you from starting the mower unless you first install the mulch plug securely on the mower (Figure 20).

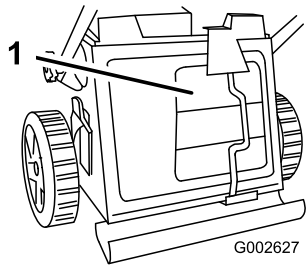

**Figure 20**

1. Mulch plug

## Bagging the Clippings

Use the grass bag when you want to collect grass and leaf clippings from the lawn.

If the side discharge chute is on the mower, remove it and lock the side discharge door (refer to Removing the Side Discharge Chute) before bagging the clippings.



**The blade is sharp; contacting the blade can result in serious personal injury.**

**Stop the engine and wait for all moving parts to stop before leaving the operating position.**

## Installing the Grass Bag

1. Rotate the latch rod to the right and remove the mulch plug (Figure 21).

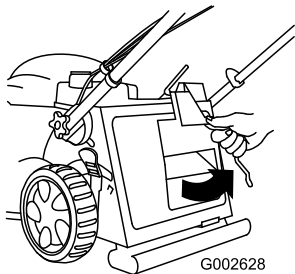

**Figure 21**

2. Route the starter rope around the lower rope guide (Figure 22).

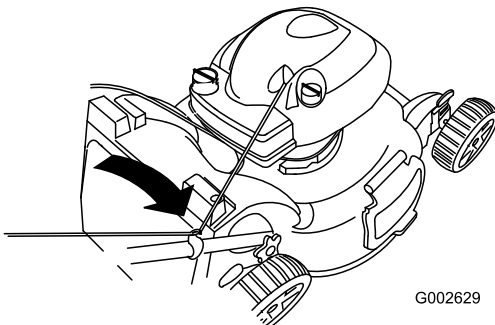
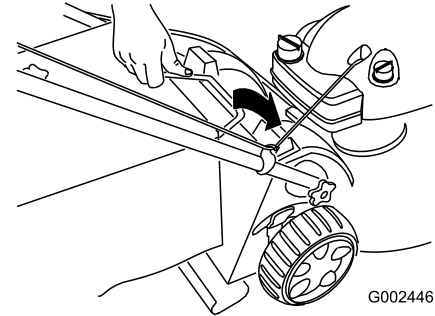

**Figure 22**

**Note:** The lower rope guide releases the starter rope when you pull the recoil start handle.

3. Insert the grass bag handle into the grooves at the top of the mower (Figure 23).

**Important:** The mower has a safety switch that prevents you from starting the mower unless you first install the grass bag securely on the mower.



**Figure 23**

## Removing the Grass Bag

1. Route the starter rope around the lower rope guide (Figure 24).

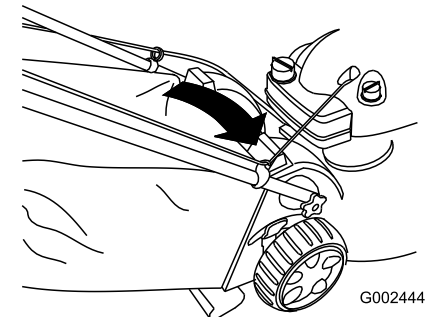

**Figure 24**

2. Lift the grass bag handle out from the grooves at the top of the mower and remove the bag from the mower.

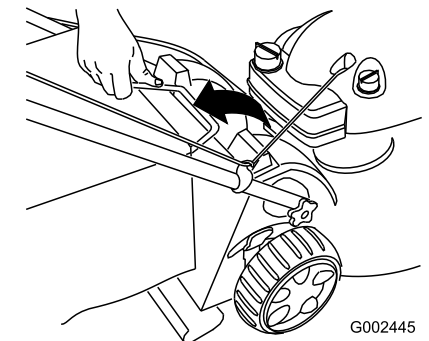

**Figure 25**

3. Insert the mulch plug and rotate the latch rod until it locks into place at both the top and the bottom (Figure 26).

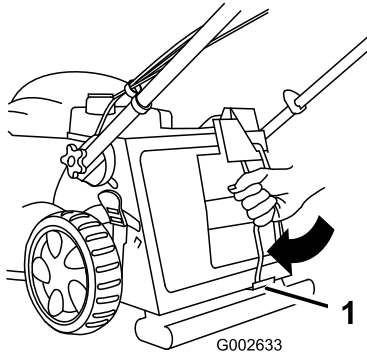

**Figure 26**

1. Latch rod locked in place

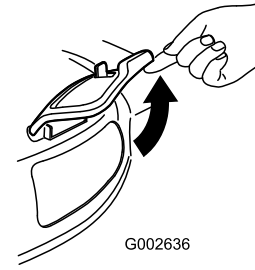

**Figure 29**

3. Install the side discharge chute and close the door onto the chute (Figure 30).

## Side-discharging the Clippings

Use the side discharge for cutting very tall grass.

If the bag is on the mower, remove it and insert the mulch plug (refer to Removing the Grass Bag) before side-discharging the clippings.

**Important:** The mower has a safety switch that prevents you from starting the mower unless you first install the mulch plug securely on the mower (Figure 27).

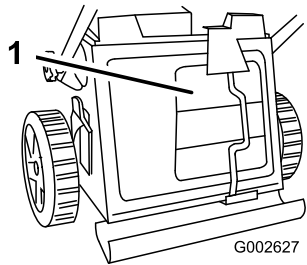

**Figure 27**

## Installing the Side Discharge Chute

1. Unlock the side discharge door (Figure 28).

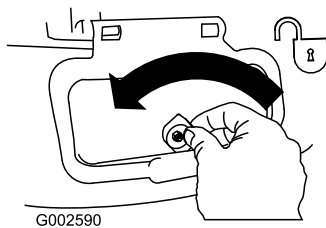

**Figure 28**

2. Lift open the side discharge door (Figure 29).

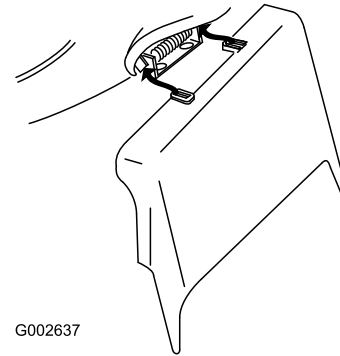
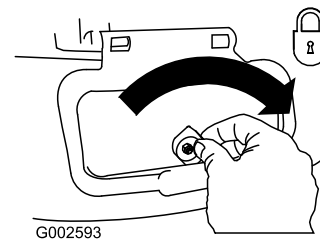

**Figure 30**

## Removing the Side Discharge Chute

To remove the side discharge chute, reverse the steps above.

**Important:** Lock the side discharge door after you close it (Figure 31).



**Figure 31**

## Operating Tips

### General Mowing Tips

- Clear the area of sticks, stones, wire, branches, and other debris that the blade could hit.
- Avoid striking solid objects with the blade. Never deliberately mow over any object.
- If the mower strikes an object or starts to vibrate, immediately stop the engine, disconnect the wire from the spark plug, and examine the mower for damage.
- For best performance, install a new blade before the cutting season begins.
- Replace the blade when necessary with a Lawn-Boy replacement blade.

## Cutting Grass

- Cut only about a third of the grass blade at a time. Do not cut below the 2 inch (51 mm) setting unless the grass is sparse or it is late fall when grass growth begins to slow down. Refer to Adjusting the Cutting Height.
- When cutting grass over 6 inches (15 cm) tall, mow at the highest cutting height setting and walk slower; then mow again at a lower setting for the best lawn appearance. If the grass is too long, the mower may plug and cause the engine to stall.
- Mow only dry grass or leaves. Wet grass and leaves tend to clump on the yard and can cause the mower to plug or the engine to stall.



**Wet grass or leaves can cause serious injury if you slip and contact the blade. Mow only in dry conditions.**

- Alternate the mowing direction. This helps disperse the clippings over the lawn for even fertilization.
- If the finished lawn appearance is unsatisfactory, try one or more of the following:
  - Replace the blade or have it sharpened.
  - Walk at a slower pace while mowing.
  - Raise the cutting height on your mower.
  - Cut the grass more frequently.
  - Overlap cutting swaths instead of cutting a full swath with each pass.
  - Set the cutting height on the front wheels one notch lower than the rear wheels. For example, set the front wheels at 2 inches (51 mm) and the rear wheels at 2-1/2 inches (64 mm).

## Cutting Leaves

- After cutting the lawn, ensure that half of the lawn shows through the cut leaf cover. You may need to make more than one pass over the leaves.
- If there are more than 5 inches (13 cm) of leaves on the lawn, set the front cutting height one or two notches higher than the rear cutting height.
- Slow down your mowing speed if the mower does not cut the leaves finely enough.

# Maintenance

**Note:** Determine the left and right sides of the machine from the normal operating position.

## Recommended Maintenance Schedule(s)

Maintenance Service Interval	Maintenance Procedure
After the first 2 operating hours	<ul style="list-style-type: none"> <li>• Change the engine oil.</li> </ul>
Before each use or daily	<ul style="list-style-type: none"> <li>• Check the engine oil level.</li> <li>• Ensure that the engine stops within 3 seconds after releasing the blade control bar.</li> <li>• Clean grass clippings and dirt from under the mower.</li> </ul>
Before storage	<ul style="list-style-type: none"> <li>• Empty the fuel tank before repairs as directed and before annual storage.</li> </ul>
Yearly	<ul style="list-style-type: none"> <li>• Replace the air filter (more frequently in dusty operating conditions).</li> <li>• Change the engine oil.</li> <li>• Lubricate the wheel gears.</li> <li>• Replace the blade or have it sharpened (more frequently if the edge dulls quickly).</li> <li>• Refer to your Engine Operator's Manual for any additional yearly maintenance procedures.</li> </ul>

**Important:** Refer to your Engine Operator's Manual for additional maintenance procedures.

## Preparing for Maintenance

1. Stop the engine and wait for all moving parts to stop.
2. Disconnect the spark plug wire from the spark plug (Figure 32) before performing any maintenance procedure.

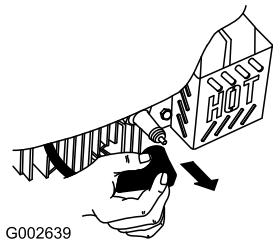

**Figure 32**

3. After performing the maintenance procedure(s), connect the spark plug wire to the spark plug.

**Important:** Before tipping the mower to change the oil or replace the blade, allow the fuel tank to run dry through normal usage. If you must tip the mower prior to running out of fuel, use a hand fuel pump to remove the fuel. Always tip the mower onto its side with the air filter up.



**Tipping the mower may cause the fuel to leak. Gasoline is flammable, explosive and can cause personal injury.**

**Run the engine dry or remove the gasoline with a hand pump; never siphon.**

## Replacing the Air Filter

Replace the air filter yearly; replace it more frequently in dusty operating conditions.

1. Perform the pre-maintenance procedures; refer to Preparing for Maintenance.
2. Rotate the air filter cover to remove it (Figure 33).

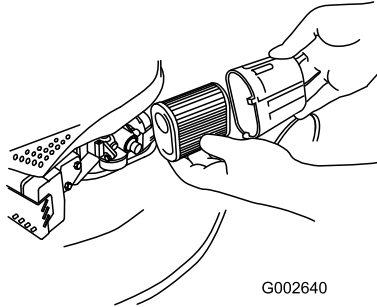

**Figure 33**

3. Replace the air filter.
4. Install the cover.

## Changing the Engine Oil

Change the engine oil after the first 2 operating hours; change it yearly thereafter.

Run the engine a few minutes before changing the oil to warm it. Warm oil flows better and carries more contaminants.

1. Perform the pre-maintenance procedures; refer to Preparing for Maintenance.
2. Remove the dipstick (Figure 34).

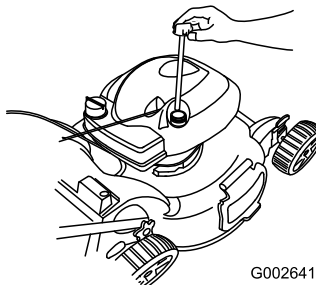

**Figure 34**

3. Tip the mower onto its side, with the air filter up, to drain the used oil out through the oil fill tube (Figure 35).

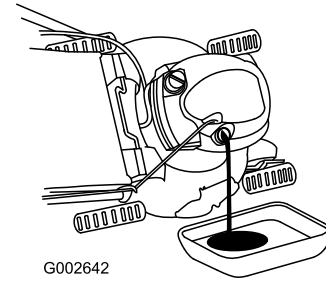

**Figure 35**

4. Slowly pour oil into the oil fill tube until the oil level reaches the **Full** line on the dipstick (Figure 36). **Do not overfill.** (Max. fill: 20 oz., type: SAE 30W detergent oil with an API service classification of SF, SG, SH, SJ, SL, or higher.)

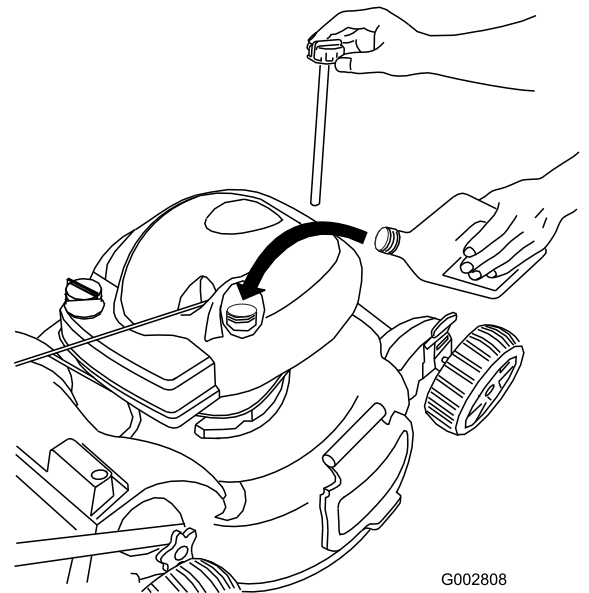
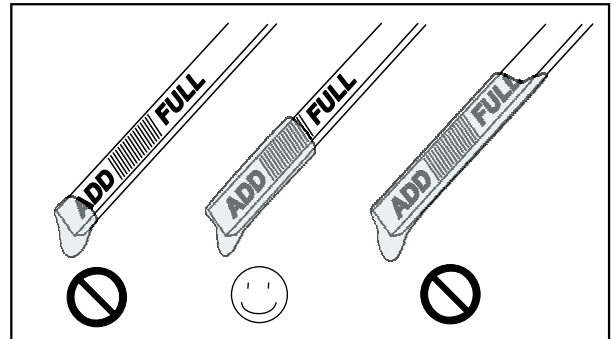

**Figure 36**

**Note:** If you overfill the engine, pour some oil out of it as directed in 3 above.

5. Install the dipstick securely.
6. Dispose of the used oil properly at a local recycling center.

## Lubricating the Wheel Gears

1. Remove the wheel bolt in the center of each **rear** wheel and remove the rear wheels.
2. Apply a lubricating oil to the inner and outer sides of the gear as shown in Figure 37.

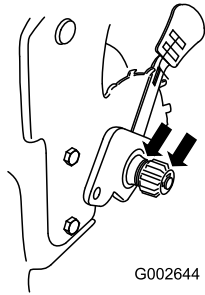

**Figure 37**

3. Install the front wheels.

## Replacing the Blade

**Important:** You will need a torque wrench to install the blade properly. If you do not have a torque wrench or are uncomfortable performing this procedure, contact an Authorized Service Dealer.

Examine the blade whenever you run out of gasoline. If the blade is damaged or cracked, replace it immediately. If the blade edge is dull or nicked, have it sharpened or replace it.



The blade is sharp; contacting the blade can result in serious personal injury.

Wear gloves when servicing the blade.

1. Disconnect the spark plug wire from the spark plug. Refer to Preparing for Maintenance.
2. Tip the mower onto its side, with the air filter up.
3. Use a block of wood to hold the blade steady (Figure 38).

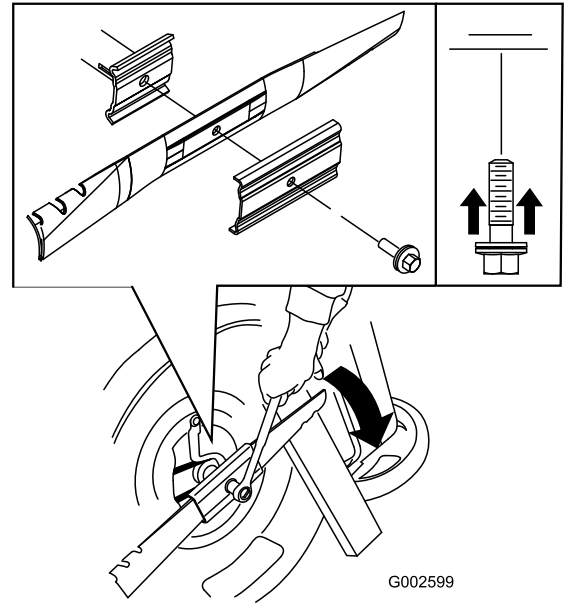

**Figure 38**

4. Remove the blade, saving all mounting hardware (Figure 38).
5. Install the new blade and all mounting hardware (Figure 38).

**Important:** Position the curved ends of the blade to point toward the mower housing.

6. Use a torque wrench to tighten the blade bolt to 60 ft-lb (82 N·m).

**Important:** A bolt torqued to 60 ft-lb (82 N·m) is very tight. While holding the blade with a block of wood, put your weight behind the ratchet or wrench and tighten the bolt securely. This bolt is very difficult to overtighten.

## Cleaning the Mower



The mower may dislodge material from under the mower housing.

- Wear eye protection.
- Stay in the operating position (behind the handle).
- Do not allow bystanders in the area.

1. With the engine running on a flat paved surface, spray a stream of water in front of the **right** rear wheel (Figure 39).

The water will splash into the path of the blade, cleaning out the clippings.



**Figure 39**

2. When no more clippings come out, stop the water and move the mower to a dry area.
3. Run the engine for a few minutes to dry the housing to prevent it from rusting.

## Storage

Store the mower in a cool, clean, dry place.

## Preparing the Mower for Storage



**Gasoline vapors can explode.**

- Do not store gasoline more than 30 days.
- Do not store the mower in an enclosure near an open flame.
- Allow the engine to cool before storing it.

1. On the last refueling of the year, add fuel stabilizer to the fuel as directed by the engine manufacturer.
2. Run the mower until the engine stops from running out of fuel.
3. Prime the engine and start it again.
4. Allow the engine to run until it stops. When you can no longer start the engine, it is sufficiently dry.
5. Disconnect the wire from the spark plug and connect the wire onto the retaining post.
6. Remove the spark plug, add 1 oz. (30 ml) of oil through the spark plug hole, and pull the starter rope **slowly** several times to distribute oil throughout the cylinder to prevent cylinder corrosion during the off-season.
7. Loosely install the spark plug.
8. Tighten all nuts, bolts, and screws.

## Folding the Handle



Folding or unfolding the handle improperly can damage the cables, causing an unsafe operating condition.

- Do not damage the cables when folding or unfolding the handle.
- If a cable is damaged, contact an Authorized Service Dealer.

1. Loosen the handle knobs until you can move the upper handle freely (Figure 40).

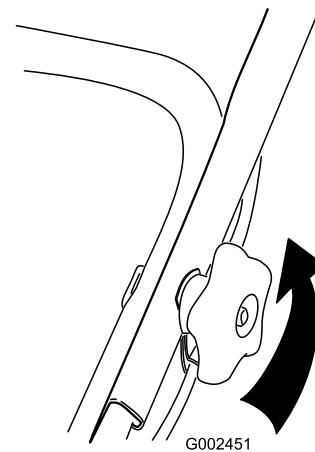

**Figure 40**

2. Fold the upper handle forward as shown in Figure 41.

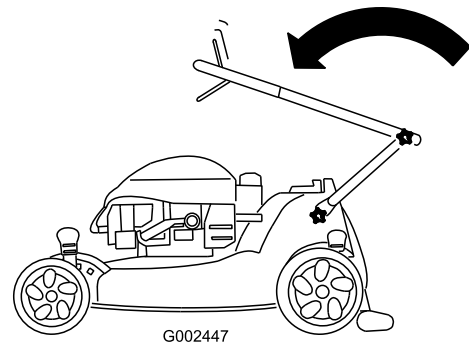

**Figure 41**

3. To unfold the handle, reverse the steps above.

## Removing the Mower from Storage

1. Remove the spark plug and spin the engine rapidly using the starter to blow the excess oil from the cylinder.
2. Install the spark plug and tighten it with a torque wrench to 15 ft-lb (20 N·m).
3. Connect the wire to the spark plug.



Gold, Insight, & Insight  
Gold Walk Power Mowers

## The Lawn-Boy No-Worry Warranty

### A Two-Year Full Warranty (Limited Warranty for Commercial Use)

#### Conditions and Products Covered

Lawn-Boy® Inc. and its affiliate, Lawn-Boy Warranty Company, pursuant to an agreement between them, jointly promise to repair any Lawn-Boy product when used for residential purposes\* if defective in materials or workmanship or if it stops functioning due to the failure of a component. The following time periods apply from the date of purchase:

Products	Warranty Period
Mowers and attachments	2-year full warranty
Batteries	1-year full warranty

This warranty covers the cost of parts and labor, but you must pay transportation costs. This warranty applies to all Lawn-Boy Gold, Insight, and Insight Gold series mowers and their attachments.

#### Limited Warranty for Commercial Use

Lawn-Boy products used for commercial, institutional, or rental use are warranted against defects in materials or workmanship for the following time periods from the original date of purchase:

Products	Warranty Period
Mowers and attachments	45 day limited warranty

Components failing due to normal wear are not covered by this warranty.

#### Items and Conditions Not Covered

There is no other express warranty except for the special emission system coverage on some products. This express warranty does not cover the following:

- Cost of regular maintenance service or parts, such as filters, fuel, lubricants, oil changes, air filter, blade sharpening/worn blade on mowers, paddles/scrapers/skids on snowthrowers, cable/linkage adjustments, or brake and clutch adjustments
- Any product or part which has been altered, misused, or requires replacement or repair due to accidents or lack of proper maintenance
- Repairs necessary due to improper battery care, electrical supply irregularities, failure to use fresh fuel (less than one month old), or failure to properly prepare the unit prior to any period of non-use over one month
- Operational misuse, neglect, or accidents
- Repairs or attempted repairs by anyone other than an Authorized Lawn-Boy Service Dealer.
- Pickup and delivery charges

#### Owner Responsibilities

You must maintain your Lawn-Boy product by following the maintenance procedures described in the *Operator's Manual*. Such routine maintenance, whether performed by a dealer or by you, is at your expense.

#### Instructions for Obtaining Warranty Service

If you think that your Lawn-Boy product contains a defect in materials or workmanship follow this procedure:

1. Contact any Authorized Lawn-Boy Service Dealer to arrange service at their dealership. To locate a dealer convenient to you, refer to the Yellow Pages of your telephone directory (look under "Lawn Mowers" or "Snow Removal") or access our website at [www.Lawn-Boy.com](http://www.Lawn-Boy.com). U.S. Customers may also call the number listed in item #3 to use our 24-hour Lawn-Boy dealer locator system.
2. Bring the product and your proof of purchase (sales receipt) to the Service Dealer. The dealer will diagnose the problem and determine if it is to be covered under warranty.
3. If for any reason you are dissatisfied with the Service Dealer's analysis or with the assistance provided, contact us at: Customer Care Department, Consumer, Lawn-Boy Warranty Company, 8111 Lyndale Avenue South, Bloomington, MN 55420-1196; or call us toll free at 1-866-216-6032 (U.S. customers) or 1-866-216-6031 (Canada customers).

#### General Conditions

All repairs covered by these warranties must be performed by an Authorized Lawn-Boy Service Dealer using Lawn-Boy approved replacement parts.

**Neither Lawn-Boy® Inc. nor Lawn-Boy Warranty Company is liable for indirect, incidental, or consequential damages in connection with the use of the Lawn-Boy products covered by these warranties, including any cost or expense of providing substitute equipment or service during reasonable periods of malfunction or non-use pending completion of repairs under these warranties. Some states do not allow exclusions of incidental or consequential damages, so the above exclusions and limitations may not apply to you. This warranty gives you specific legal rights, and you may also have other rights which vary from state to state.**

#### Countries Other than the United States or Canada

Customers who have purchased Lawn-Boy products exported from the United States or Canada should contact their Lawn-Boy Distributor (Dealer) to obtain guarantee policies for your country, province, or state. If for any reason you are dissatisfied with your Distributor's service or have difficulty obtaining guarantee information, contact the Lawn-Boy importer. If all other remedies fail, you may contact us at Lawn-Boy Warranty Company.

\* Residential purposes means use of the product on the same lot as your home. Use at more than one location is considered commercial use, and the commercial use warranty would apply.