

LAWN-BOY®

Silver Series®

Walk Power Lawn Mower

10360—220000001 and Up

10361—220000001 and Up

Operator's Manual

Para obtener una versión gratis de este manual en español, escriba a la dirección indicada más abajo. Asegúrese de indicar el modelo y el número de serie de su producto.

Pour obtenir gratuitement une version en français de ce manuel, écrivez à l'adresse ci-dessous. N'oubliez pas d'indiquer les numéros de modèle et de série de votre produit.

Lawn-Boy Inc., Attn: Parts Dept., 8111 Lyndale Ave S, Bloomington, MN 55420-1196.

Contents

	Page
Introduction	2
Safety	3
General Lawn Mower Safety	3
Safety and Instruction Decals	5
Assembly	6
Unfolding the Handle	6
Changing the Handle Height	6
Installing the Fuse	7
Before Starting	7
Filling the Crankcase with Oil	7
Filling the Fuel Tank with Gasoline	8
Operation	9
Controls	9
Starting the Engine	9
Stopping the Engine	10
Using the Self-propel Drive	10
Pulling the Lawn Mower Rearward	10
Adjusting the Cutting Height	10
Operating Tips	11
Maintenance	12
Recommended Maintenance Schedule	12
Checking the Engine Oil	13
Cleaning the Underside of the Lawn Mower Housing	13
Changing the Engine Oil	14
Replacing the Air Filter	14
Cleaning under the Belt Cover	15
Maintaining the Cutting Blade	15
Adjusting the Self-propel Drive Cable	17
Lubricating the Self-propel Drive	17
Maintaining the Spark Plug	17
Changing the Fuse	18
Charging the Battery	18
Disposing of the Battery	18
Emptying the Fuel Tank	18
Storage	19
Preparing the Fuel System	19
Preparing the Engine	19
General Information	19
Folding the Handle	19
Removing from Storage	20
Accessories	20
Installing the Rear Grass Catcher	20
Installing the Cover Plate	22
Installing the Mulch Plate	23
Troubleshooting	24
The Lawn-Boy No-Worry Warranty	28

Introduction

Read this manual carefully to learn how to operate and maintain your product properly. The information in this manual can help you and others avoid injury and product damage. Although Lawn-Boy designs and produces safe products, you are responsible for operating the product properly and safely.

Whenever you need service, genuine Lawn-Boy parts, or additional information, contact an Authorized Service Dealer or Lawn-Boy Customer Service and have the model and serial numbers of your product ready. Figure 1 illustrates the location of the model and serial numbers on the product.

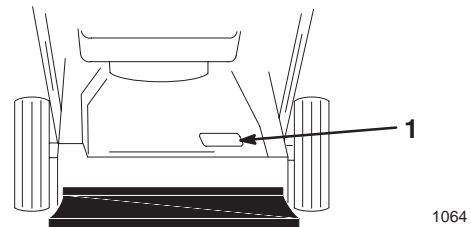

Figure 1

1. Location of the model and serial numbers

Write the product model and serial numbers in the space below:

<p>Model No. _____</p> <p>Serial No. _____</p>
--

This manual identifies potential hazards and has special safety messages that help you and others avoid personal injury and even death. **Danger**, **Warning**, and **Caution** are signal words used to identify the level of hazard. However, regardless of the hazard, be extremely careful.

Danger signals an extreme hazard that **will** cause serious injury or death if you do not follow the recommended precautions.

Warning signals a hazard that **may** cause serious injury or death if you do not follow the recommended precautions.

Caution signals a hazard that may cause minor or moderate injury if you do not follow the recommended precautions.



This manual uses two other words to highlight information. **Important** calls attention to special mechanical information and **Note:** emphasizes general information worthy of special attention.

Safety

This lawn mower meets or exceeds the CPSC blade safety requirements for walk-behind rotary lawn mowers and the B71.1 specifications of the American National Standards Institute in effect at the time of production.

Improperly using or maintaining this lawn mower can result in injury. To reduce the potential for injury, comply with these safety instructions.

Lawn-Boy designed and tested this lawn mower to offer reasonably safe service; however, **failure to comply with the following instructions may result in personal injury.**

 Warning 
<p>Engine exhaust contains carbon monoxide, an odorless, deadly poison that can kill you.</p> <p>Do not run the engine indoors or in an enclosed area.</p>

To ensure maximum safety, best performance, and to gain knowledge of the product, it is essential that you and any other operator of the lawn mower read and understand the contents of this manual before the engine is ever started. Pay particular attention to the safety alert symbol  which means *caution, warning, or danger* — “personal safety instruction.” Read and understand the instruction because it has to do with safety. Failure to comply with the instruction may result in personal injury.

General Lawn Mower Safety

The following instructions have been adapted from the ANSI/OPEI standard B71.1—1998 and ISO standard 5395:1990(E). Information or terminology specific to Lawn-Boy lawn mowers is enclosed in parenthesis.

This lawn mower is capable of amputating hands and feet and of throwing objects. Failure to observe the following safety instructions could result in serious injury or death.

Training

- Read this operator’s manual carefully. Be thoroughly familiar with the controls and the proper use of the lawn mower before starting it.
- Never allow children to operate the lawn mower. Local regulations may restrict the age of the operator.
- Never allow adults unfamiliar with these instructions to operate the lawn mower.

- Never mow while people (especially children) or pets are nearby. Stop the lawn mower if anyone enters the area.
- Tragic accidents can occur if the operator is not alert to the presence of children. Children are often attracted to the lawn mower and the mowing activity. Never assume that children will remain where you last saw them.
- Keep children out of the mowing area and under the watchful care of a responsible adult.
- Be alert and turn the lawn mower off if children enter the area.
- Use extra care when approaching blind corners, shrubs, trees, or other objects that may obscure vision.
- Keep in mind that the operator or user is responsible for accidents or hazards occurring to other people or their property.
- See the manufacturer’s instructions for proper operation and installation of accessories. Use only the accessories that are approved by the manufacturer.

Preparation

- Thoroughly inspect the area where you will use the lawn mower, and remove all stones, sticks, wires, bones, and other foreign objects.
- While mowing, always wear substantial footwear and long trousers.
- Do not operate the lawn mower when barefoot or wearing open sandals.
- Always wear safety goggles or safety glasses with side shields when operating the lawn mower.
- Warning: Gasoline is highly flammable. Take the following precautions:
 - Store fuel in containers specifically designed for this purpose.
 - Refuel outdoors only and do not smoke while refuelling.
 - Add fuel before starting the engine. Never remove the cap of the fuel tank or add gasoline while the engine is running or when the engine is hot.
 - If gasoline is spilled, do not attempt to start the engine. Move the lawn mower away from the area of spillage to avoid creating any source of ignition until the gasoline vapors have dissipated.
 - Replace all fuel tank and container caps securely.
 - If you must drain the fuel from the fuel tank, do it outdoors.
- Replace faulty mufflers.

- Before using, always visually inspect the blades, blade bolts, and cutter assembly for wear or damage. Replace worn or damaged blades and bolts in sets to preserve balance.
- On multibladed lawn mowers, use care as rotating one blade can cause the other blades to rotate.

Operation

- Do not operate the engine in a confined space where dangerous carbon monoxide fumes can collect.
- Mow only in daylight or in good artificial light.
- Always be sure of your footing on slopes.
- Walk; never run.
- Keep a firm hold on the handle.
- For wheeled rotary lawn mowers, mow across the face of slopes, never up and down.
- Exercise extreme caution when changing the direction on slopes.
- Do not mow excessively steep slopes.
- Use extreme caution when reversing or pulling the lawn mower toward you.
- Before and while moving backward, look behind and down for small children.
- Stop the blade(s) if you must tilt the lawn mower for transportation when crossing surfaces other than grass and when transporting the lawn mower to and from the area to be mowed.
- Never operate the lawn mower with damaged or missing guards or shields, or without safety devices (such as deflectors and grass catchers) in place.
- Do not change the speed settings on the engine.
- Disengage all blade and drive clutches before starting the engine.
- Start the engine carefully according to instructions and with feet well away from the blade(s).
- Do not tilt the lawn mower when starting the engine, unless you must tilt the lawn mower to start it. In this case, do not tilt it more than absolutely necessary and lift only the part which is away from the operator.
- Do not start the engine when standing in front of the discharge chute.
- Do not put your hands or feet near or under rotating parts. Keep clear of the discharge opening at all times.
- Never pick up or carry a lawn mower while the engine is running.
- Stop the engine and disconnect the spark-plug wire:

- before clearing blockages or unclogging the chute;
- before checking, cleaning, or working on the lawn mower;
- after striking a foreign object. Inspect the lawn mower for damage and make repairs before starting and operating the lawn mower; and
- if the lawn mower starts to vibrate abnormally (check it immediately).

- Stop the engine:
 - whenever you leave the lawn mower; and
 - before refuelling.
- Reduce the throttle setting during engine run-out and, if the engine has a shutoff valve, turn the fuel off after mowing.
- Stop the blade(s) when crossing gravel drives, walks, or roads.
- Shut the engine off and wait until the blade comes to a complete stop before removing the grass catcher.
- Do not operate the lawn mower while under the influence of alcohol or drugs.
- If the lawn mower should start to vibrate abnormally, stop the engine and check immediately for the cause. Vibration is generally a warning of trouble.

Slopes are a major factor related to slip and fall accidents which can result in a severe injury. If you feel uneasy on a slope, do not mow it.

- Watch for holes, ruts, or bumps. Tall grass can hide obstacles.
- Do not mow near drop-offs, ditches, or embankments. You could lose your footing or balance.
- Do not mow on wet grass. Reduced footing could cause slipping.

Maintenance and Storage

- Keep all nuts, bolts (especially blade attachment bolts), and screws tight to ensure that the lawn mower is in safe working condition.
- Never store the lawn mower with gasoline in the tank inside a building where fumes may reach an open flame or spark.
- Allow the engine to cool before storing the lawn mower in any enclosure.
- To reduce the fire hazard, keep the engine, muffler, battery compartment, and gasoline storage area free of grass, leaves, or excessive grease.
- Check the grass catcher frequently for wear or deterioration.

- Replace worn or damaged parts.
- Use extra care when handling gasoline; gasoline vapors are explosive.
- Never tamper with safety devices. Check their proper operation regularly.
- Keep the lawn mower free of grass, leaves, or other debris buildup. Clean up any oil or fuel that spills.
- Stop and inspect the lawn mower if you strike an object. Repair the lawn mower, if necessary, before starting the engine.
- Never attempt to make wheel height adjustments while the engine is running.
- Grass catcher components are subject to wear, damage, and deterioration, which could expose moving parts or allow objects to be thrown. Frequently check the components and replace them with the manufacturer's recommended parts when necessary.
- Lawn mower blades are sharp and can cut. Wrap the blade(s) or wear gloves, and use extra caution when servicing them.
- Do not change the speed settings on the engine.
- If you must drain the fuel from the fuel tank, do it outdoors.
- To ensure the best performance and safety, purchase only genuine Lawn-Boy replacement parts and accessories.
- Maintain or replace safety and instruction decals when necessary.

Safety and Instruction Decals



Safety decals and instructions are easily visible to the operator and are located near any area of potential danger. Replace any decal that is damaged or lost.



**On Mower Housing
(Part No. 43-8480)**



**On Mower Housing
(Part No. 99-6018)**



**By Front Wheels
(Part No. 92-2914 Right)
(Part No. 92-2915 Left)**



**On Muffler Guard
(Part No. 65-2690)**

**On Mower Housing
(Part No. 93-7250)**

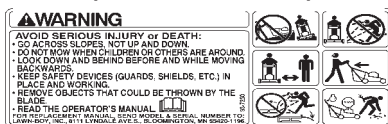

**On Mower Housing
(Part No. 92-4851)**



**On Wire Harness (Electric Start Model only)
(Part No. 104-7953)**



Assembly

Note: Determine the left and right sides of the machine from the normal operating position.

Unfolding the Handle

Warning

Folding or unfolding the handle improperly can pinch, stretch, or damage one or more of the cables. Any pinched, stretched, or damaged cable may cause an operational failure that results in an unsafe operating condition.

- Do not pinch, stretch, or damage the cables.
- Handle the cables with care when folding or unfolding the handle.
- Do not use the lawn mower if one or more of the cables are pinched, stretched, or damaged. Contact your Authorized Service Dealer.

1. Loosen the handle knobs and lift the top handle half in an arc until the handle halves are in line and nest together (Fig. 2).

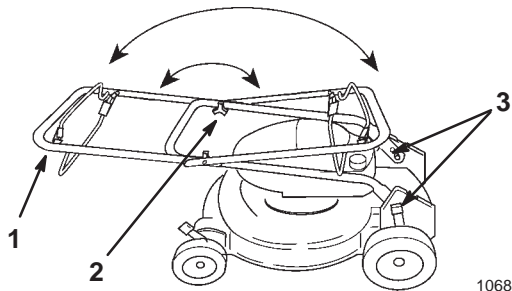

Figure 2

1. Top handle half
2. Knob (2)
3. Stops

2. Tighten the knobs securely.
3. Rotate the handle toward the rear of the lawn mower until it snaps into the stops in the handle brackets (Fig. 2).

Changing the Handle Height

The handle has two height settings: high and low (Fig. 3). Choose a handle height setting that is most comfortable for you.

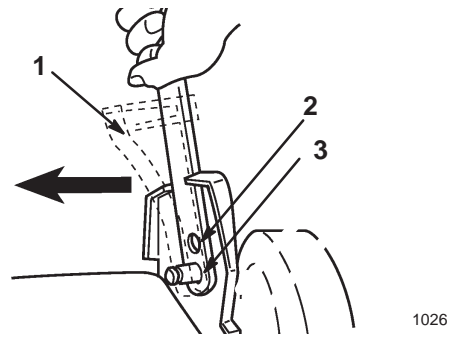

Figure 3

1. Cable anchor
2. Low setting
3. High setting

1. Squeeze the bottom handle section (both sides) inward off the pins.

2. Position the handle and cable anchor over the pins at the desired height (Fig. 3).

Note: You may need to loosen and slightly move the belt cover.

3. Adjust the cable. Refer to Adjusting the Self-propel Drive Cable on page 17.

Installing the Fuse

Electric Start Model only

The fuse protects the electric starter. If the battery does not charge or the engine does not turn with the electric starter, the fuse may be blown. Use a 40-amp plug-in type fuse.

1. Remove the battery box cover (Fig. 4).

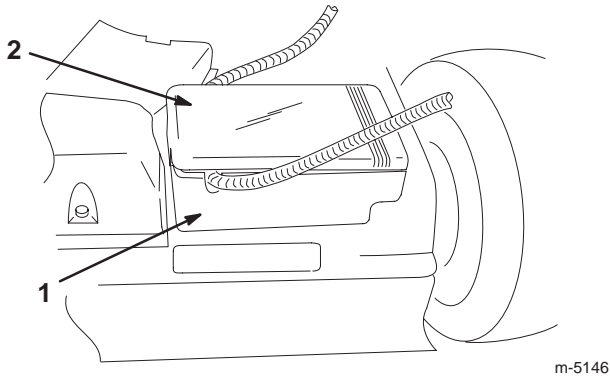

Figure 4

1. Battery box
2. Battery box cover

Note: Use a flat-head screw driver to unclip the battery cover (Fig. 5). Unclip both ends of the battery cover before removing it to prevent damaging it.

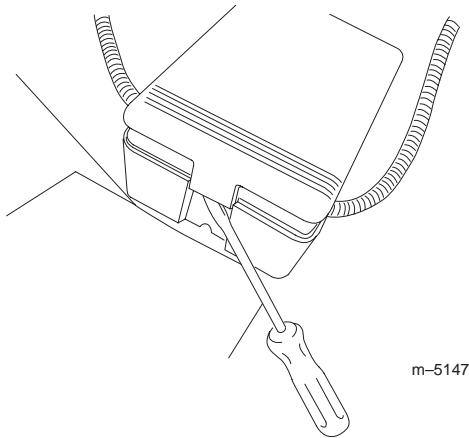

Figure 5

2. Install the fuse in the fuse holder as shown in Figure 6.

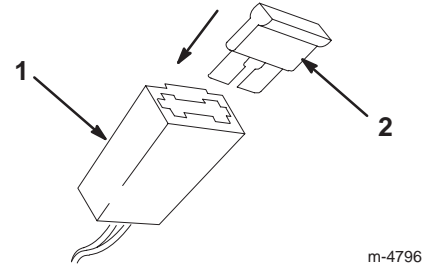

Figure 6

1. Fuse Holder
2. Fuse

3. Install the battery box cover.

Before Starting

Filling the Crankcase with Oil

Your Lawn-Boy lawn mower comes without oil in the crankcase. However, your lawn mower comes with a 20 oz. (0.59 liter) bottle of oil.

Fill the engine crankcase with a maximum of 21 oz. (0.62 liters) of SAE 30 oil. Use only a high-quality detergent oil that has the American Petroleum Institute (API) service classification SF, SG, SH, or SJ.

To add oil:

1. Move the lawn mower to a level surface.
2. Clean around the dipstick (Fig. 7).

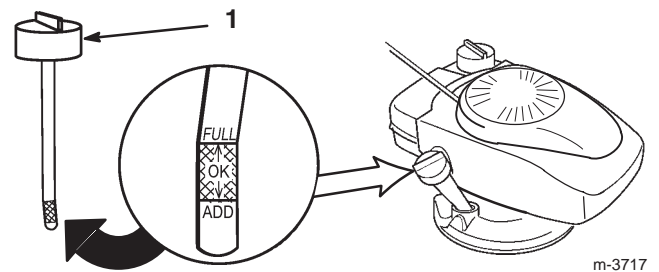

Figure 7

1. Dipstick

3. Remove the dipstick by rotating the cap counterclockwise and pulling it out.
4. Wipe the dipstick clean with a clean cloth.
5. Insert the dipstick into the filler neck, then remove it.

Note: To ensure an accurate oil level reading, you must fully insert the dipstick.

6. Read the oil level on the dipstick (Fig. 7).

- If the oil level reading is below the **Add** mark on the dipstick, **slowly** pour only enough oil into the filler hole to raise the oil level to the **Full** mark on the dipstick.

Important Do not overfill the crankcase with oil and run the engine; engine damage will result. Drain the excess oil until the oil level on the dipstick reads **Full**.

- Insert the dipstick into the filler neck and rotate the cap clockwise until it is tight.

Filling the Fuel Tank with Gasoline

For best results, use clean, fresh, lead-free gasoline with an octane rating of 87 or higher. To ensure freshness, purchase only the quantity of gasoline that you expect to use in 30 days. Using unleaded gasoline results in fewer combustion deposits and longer engine life. You may use leaded gasoline if unleaded gasoline is not available.

Important Do not add oil to the gasoline.

Important Do not use methanol, gasoline containing methanol, gasohol containing more than 10% ethanol, premium gasoline, or white gas. Using these fuels can damage the engine's fuel system.

Important Do not use gasoline that is more than 30 days old.

! **Danger** !

In certain conditions, gasoline is extremely flammable and highly explosive. A fire or explosion from gasoline can burn you and others and can damage property.

- **Fill the fuel tank outdoors, in an open area, and when the engine is cold. Wipe up any gasoline that spills.**
- **Do not fill the fuel tank completely full. Add gasoline to the fuel tank until the level is 1/4 to 1/2 in. (6 to 13 mm) below the bottom of the filler neck. This empty space in the tank allows the gasoline to expand.**
- **Never smoke when handling gasoline, and stay away from an open flame or where a spark may ignite the gasoline fumes.**
- **Store gasoline in an approved fuel container and keep it out of the reach of children.**
- **Never buy more than a 30-day supply of gasoline.**

! **Danger** !

When fueling, under certain circumstances, a static charge can develop, igniting the gasoline. A fire or explosion from gasoline can burn you and others and damage property.

- **Always place gasoline containers on the ground and away from your vehicle before filling.**
- **Do not fill gasoline containers inside a vehicle or on a truck or trailer bed because interior carpets or plastic truck bed liners may insulate the container and slow the loss of any static charge.**
- **When practical, remove gasoline-powered equipment from the truck or trailer and refuel the equipment with its wheels on the ground.**
- **If this is not possible, then refuel such equipment on a truck or trailer from a portable container, not from a gasoline dispenser nozzle.**
- **If you must use a gasoline dispenser nozzle, keep the nozzle in contact with the rim of the fuel tank or container opening at all times until fueling is complete.**

- Disconnect the wire from the spark plug (Fig. 8).

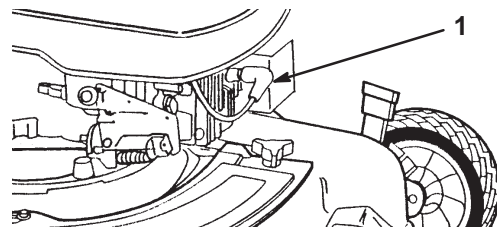

Figure 8

- Spark-plug wire

- Clean around the fuel tank cap (Fig. 9).

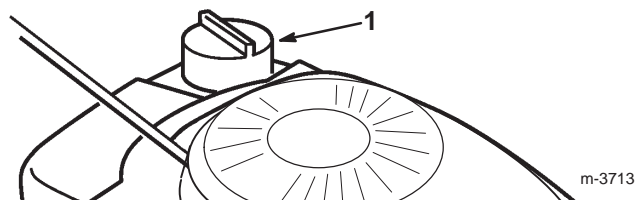

Figure 9

- Fuel tank cap

Use a fuel stabilizer/conditioner regularly during operation and storage. A stabilizer/conditioner cleans the engine during operation and prevents gum-like varnish deposits from forming in the engine during periods of storage.

Important Do not use fuel additives other than a fuel stabilizer/conditioner. Do not use fuel stabilizers with an alcohol base such as ethanol, methanol, or isopropanol.

3. Remove the cap from the tank (Fig. 9).
4. Fill the fuel tank with unleaded gasoline to within 1/4 to 1/2 in. (6 to 13 mm) from the top of the tank. **Do not fill into the filler neck. The gasoline must have room to expand.**
5. Install the fuel tank cap and wipe up any spilled gasoline.

Operation

Note: Determine the left and right sides of the machine from the normal operating position.

Each time before you mow, ensure that the self-propel drive and the control bar operate properly. When you release the control bar, the engine and the self-propel drive should stop. If they do not, contact an Authorized Service Dealer.

Controls

The starter handle, the blade control bail, and the self-propel drive bail are on the upper handle as shown in Figure 10.

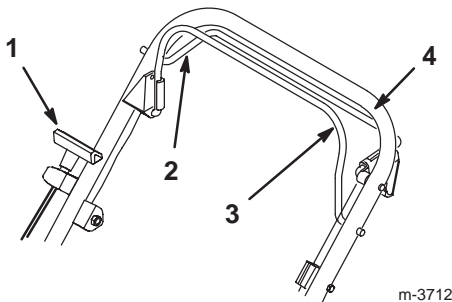

Figure 10

- | | |
|---------------------------|-----------------------|
| 1. Starter handle | 3. Blade control bail |
| 2. Self-propel drive bail | 4. Upper handle |

Starting the Engine

1. Connect the wire onto the spark plug (Fig. 8).
2. Push the primer three times, waiting two seconds between each push (Fig. 11).

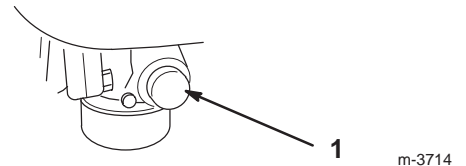

Figure 11

1. Primer

Note: If the temperature is 55°F (13°C) or below, push the primer five times, waiting two seconds between each push.

Note: Do not use the primer to start a warm engine after a brief shutdown. However, cool weather may require you to prime the engine again.

3. Hold the blade control bail against the upper handle (Fig. 10).

4. Start the lawn mower.

Manual Starting—Pull the starter handle lightly until you feel resistance, then pull it sharply (Fig. 10). Allow the rope return to the handle slowly.

Electric Starting (Electric Start Model only)—Insert the key into the switch. Turn the key to the right and release it when the engine starts (Fig. 12).

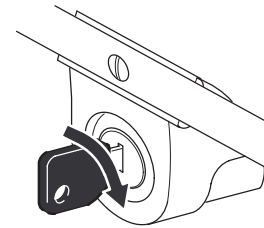

Figure 12

Note: If the battery charge is too low to start the engine, start the engine manually. To charge the battery, refer to Charging the Battery on page 18.

Note: If the engine fails to start after three attempts, repeat steps 2 through 4.

Stopping the Engine

Release the blade control bail (Fig. 13). Both the engine and the blade should stop. If they do not stop properly, contact your Authorized Service Dealer.

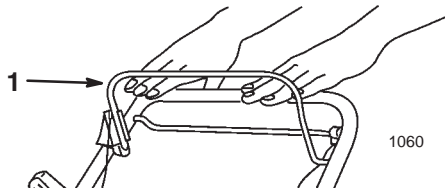

Figure 13

1. Blade control bail

Using the Self-propel Drive

1. To operate the self-propel drive, squeeze the self-propel drive bail against the handle and hold it (Fig. 14).

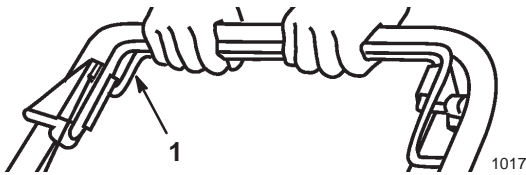

Figure 14

1. Self-propel drive bail

Note: The maximum self-propel ground speed is fixed. To reduce the ground speed, increase the space between the bail and the handle.

2. To disengage the self-propel drive, release the self-propel drive bail (Fig. 15).

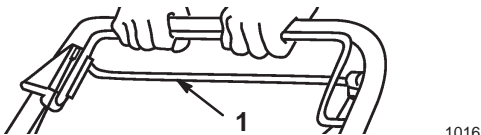

Figure 15

1. Self-propel drive bail

Pulling the Lawn Mower Rearward

The lawn mower comes with free-wheeling clutches which make it easier to pull the lawn mower rearward. To disengage the clutches, you may need to push the lawn mower forward one inch (2.5 cm) or more after you release the self-propel drive bail.

For example, if you approach an object (such as a tree or a bush) from which you want to pull back the lawn mower, release the self-propel drive bail when the lawn mower is about six inches (15 cm) away from the object. The momentum of the lawn mower should carry it forward at least one inch (2.5 cm) and disengage the clutches. You should then be able to easily pull the lawn mower rearward.

Adjusting the Cutting Height

Each wheel adjusts individually with a wheel height adjustment lever. Cutting heights are 1 in. (25 mm); 1-1/2 in. (38 mm); 2 in. (51 mm); 2-1/2 in. (64 mm); 3 in. (76 mm); and 3-1/2 in. (89 mm).



Danger



Adjusting the cutting height levers could bring your hands into contact with a moving blade and result in serious injury.

- Stop the engine and wait for all movement to stop before adjusting the cutting height.
- Do not put fingers under the housing when adjusting the cutting height.

1. Pull the wheel height adjustment lever toward the wheel and move it to the desired position (Fig. 16).

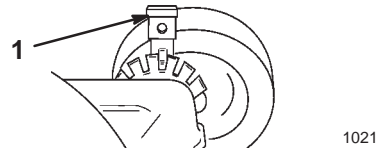

Figure 16



1. Wheel height adjustment lever

2. Release the wheel height adjustment lever and seat it securely in the desired notch.

Note: Set all four wheels to the same height.

Operating Tips

- Review the safety instructions and read this manual carefully before operating the lawn mower.
- Clear the area of sticks, stones, wire, branches, and other debris that the lawn mower could pick up or the blade could hit and throw objects.
- Keep everyone, especially children and pets, away from the area of operation.
- Avoid striking trees, walls, curbs, or other solid objects. Never deliberately mow over any object.
- If the lawn mower strikes an object or starts to vibrate, immediately stop the engine, disconnect the spark plug wire, and examine the lawn mower for damage.
- Maintain a **sharp blade** throughout the cutting season. Periodically file down nicks on blade.
- Replace the blade when necessary with an original Lawn-Boy replacement blade.
- Mow only dry grass or leaves. Wet grass and leaves tend to clump on the yard and may cause the lawn mower to plug or the engine to stall.

 Warning 
Wet grass or leaves can cause you to slip, contact the blade, and seriously injure you.
Mow only in dry conditions.

- Clean clippings or leaves from the underside of the lawn mower deck after each mowing. See Cleaning the Lawn Mower Housing on page 13.
- Keep the engine in good running condition.
- Clean the air filter frequently. Mulching stirs up more clippings and dust which clogs the air filter and reduces engine performance.
- To achieve the best mulching action, set the lawn mower height of cut so that the lawn mower cuts no more than a third of the grass stem or a maximum of one-inch (25 mm) long clippings. If you try to mulch more or if the grass is very lush, the mulching action will be poor. Under these conditions, use the side discharge or grass catcher. A few days later, install the mulch plate on your lawn mower to resume mulching.

Cutting Grass

- In the summer, cut the grass at the 2, 2-1/2, or 3-inch (51, 64, or 76 mm) cutting height settings. Only cut off about one-third of the grass blade. Do not cut below the two-inch setting unless the grass is sparse or it is late autumn when the grass growth begins to slow down.

- When cutting grass over six inches tall, first mow using the highest cutting height setting and walking slower; then mow again at a lower setting for best lawn appearance. If grass is too long and leaves clumps on top of the lawn, the lawn mower may plug and cause engine to stall.
- Alternate the mowing direction. This helps disperse the clippings over the lawn for even fertilization.

If the finished cut lawn appearance is unsatisfactory, try one or more of the following:

- Sharpen the blade.
- Walk at a slower pace while mowing.
- Raise the cutting height on your lawn mower.
- Cut the grass more frequently.
- Overlap the cutting swaths instead of cutting a full swath with each pass.
- Set the cutting height on the front wheels one notch lower than the rear wheels.

Cutting Leaves

- After cutting the lawn, make sure that half of the lawn shows through the cut leaf cover. You may need to make one or more passes over the leaves.
- For light leaf coverage, set all the wheels at the same cutting height.
- If there are more than 5 inches (12.7 cm) of leaves on the lawn, set the front wheels one or two notches higher than the rear wheels. This makes it easier to feed the leaves under the lawn mower deck.
- Slow down your mowing speed if the lawn mower does not cut the leaves finely enough.
- If you cut up a lot of oak leaves, you can add lime to your grass in the spring to reduce the acidity of the oak leaves.

Maintenance



Note: Determine the left and right sides of the machine from the normal operating position.

Recommended Maintenance Schedule

Maintenance Service Interval	Maintenance Procedure
Each Use	<ul style="list-style-type: none"> • Check the engine oil level. • Remove grass clippings and dirt from under the housing.
5 Hours	<ul style="list-style-type: none"> • Check the blade and the engine mounting fasteners. Tighten them if they are loose.
25 Hours	<ul style="list-style-type: none"> • Change the engine oil.¹ • Replace the air filter; replace it more frequently in dusty operating conditions. • Remove grass clippings and debris from the under the belt cover and around the drive belt.
50 Hours	<ul style="list-style-type: none"> • Sharpen or replace the blade; maintain it more frequently if the edge dulls quickly in rough or in sandy conditions. • Check the stopping time of the blade brake. The blade must stop within three seconds of releasing the bail; if it does not, contact an Authorized Service Dealer for repair. • Check and adjust the self-propel drive cable. • Grease the rear-height adjustor levers. • Check for leaks in the fuel system and/or a deteriorating fuel hose. Replace parts if necessary.
100 Hours	<ul style="list-style-type: none"> • Clean, inspect, and gap the spark plug. Replace the spark plug if necessary. • Clean the cooling system; remove grass clippings, debris, or dirt from the engine air cooling fins and starter. Clean the system more frequently in dirty or high-chaff conditions.
Storage	<ul style="list-style-type: none"> • Empty the fuel tank before repairs as directed or before storage. • Charge the battery monthly and before storage.

¹Change the engine oil after the first two operating hours.

Important Refer to your engine operator's manual for additional maintenance procedures.

	Caution	
<p>If you leave the wire on the spark plug, someone could accidentally start the engine and seriously injure you or other bystanders.</p> <p>Disconnect the wire from the spark plug before you do any maintenance. Set the wire aside so that it does not accidentally contact the spark plug.</p>		

Checking the Engine Oil

Before you use the lawn mower, make sure that the oil level is between the **Add** and the **Full** marks as shown on the dipstick (Fig. 7). If the oil level is below the **Add** mark, add oil. Refer to Filling the Crankcase with Oil on page 7.

Cleaning the Underside of the Lawn Mower Housing

A clean lawn mower housing provides the best cutting performance. Check for grass buildup and clean the housing after each use.

Washing Method

1. Move the lawn mower to a flat concrete or asphalt surface near a garden hose.
2. Start the engine.
3. Hold the running garden hose at handle level and direct the water to flow on the ground just in front of the right rear wheel (Fig. 17).

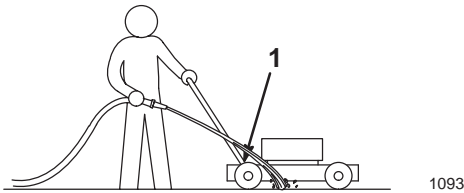

Figure 17

1. Rear right wheel

The blade will draw in water and wash out the clippings. Let the water run until the clippings no longer come out from under the housing.

4. Stop the engine and wait for all moving parts to stop.
5. Turn off the garden hose.
6. Start the lawn mower and let it run for a few minutes to dry it off.
7. While the engine runs, engage and disengage the traction drive several times to dry it out.

Scraping Method

If washing does not remove all debris from under the lawn mower, tip the housing and scrape it clean.

1. Run the engine dry or remove the fuel when the engine is cool.



Warning



Tipping the lawn mower may cause the fuel to leak from the carburetor or the fuel tank. Gasoline is extremely flammable, highly explosive, and, under certain conditions, can cause personal injury or property damage.

Avoid fuel spills by running the engine dry or by removing the gasoline with a hand pump; never siphon.

2. Disconnect the wire from the spark plug (Fig. 8).
3. Tip the lawn mower onto its **right** side (air filter up) (Fig. 18).

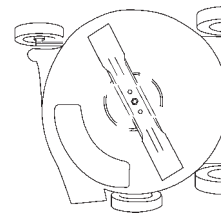

Figure 18

Note: When you tip the lawn mower onto its side, rotate the blade as little as possible to avoid starting problems.

4. Scrape the built-up grass clippings and dirt from the lawn mower housing with a hardwood scraper.
5. Tip the lawn mower upright.
6. Connect the wire to the spark plug.

Changing the Engine Oil

Change the engine oil after the first two hours of operation and then after every 25 operating hours or every season. Run the engine just before changing the oil to warm the oil. Warm oil flows better and carries more contaminants.

Note: Change the oil more frequently when operating the lawn mower under a heavy load or in high temperatures.

! **Warning** !

Tipping the lawn mower may cause the fuel to leak from the carburetor or the fuel tank. Gasoline is extremely flammable, highly explosive and under certain conditions can cause personal injury or property damage.

Avoid fuel spills by running the engine dry or removing gasoline with a hand pump; never siphon.

Draining the Oil above the Lawn Mower Deck

1. Drain the gasoline from the fuel tank; refer to steps 1 through 4 of Emptying the Fuel Tank on page 18.
2. Drain the oil from the oil fill tube at the dipstick into an appropriate container (Fig. 19).
3. Recycle the used oil according to local codes.

Note: There is an oil drain plug on the bottom of the engine visible from under the lawn mower deck. However, because the plug is not easily accessible, Lawn-Boy does not recommend draining the oil from below the deck.

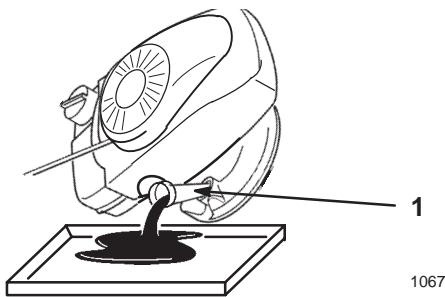

Figure 19

1. Oil fill tube

4. Fill the crankcase to the **Full** line on the dipstick with fresh oil. Refer to Filling the Crankcase with Oil on page 7.
5. Check the oil level and insert the dipstick.
6. Wipe up any spilled oil.

Replacing the Air Filter

Replace the filter every 100 operating hours or yearly; replace it more frequently under dusty conditions.

Important Do not operate the engine without the air filter element; extreme engine wear or damage will occur.

1. Turn the cover counterclockwise and remove the cover and the filter (Fig. 20).

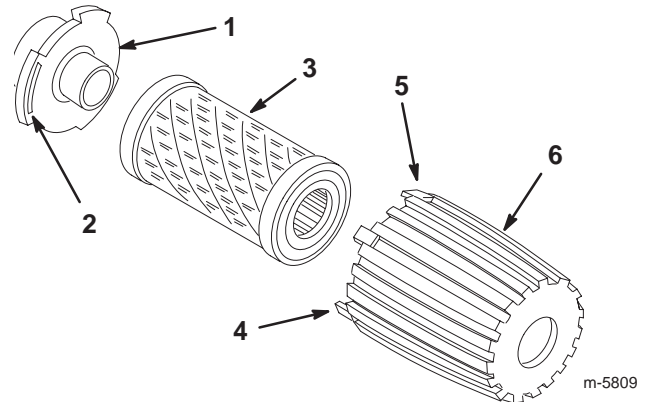

Figure 20

1. Flange
 2. Slot
 3. Filter
 4. Tab
 5. Retainer
 6. Cover
2. Clean the cover and the flange thoroughly (Fig. 20).
 3. Insert the new filter into the cover (Fig. 20).
 4. Position the cover and the filter against the flange with the tab on the cover inserted into the lower left corner of the slot in the flange (Fig. 20).
 5. Push the cover firmly against the flange and turn it clockwise as far as it will go.

Note: Ensure that the retainers lock around the flange.

Cleaning under the Belt Cover

Under certain conditions, clippings can collect under the belt drive cover and in the pulley groove. This can cause the belt to slip, the self-propel drive to lose power, or the the self-propel drive not to disengage.

Clean grass clippings and debris from under the belt cover every 25 operating hours.

1. Remove the screw from the belt cover and slide the belt cover to the rear, unhooking the tab on the front of the cover from the deck opening (Fig. 21).

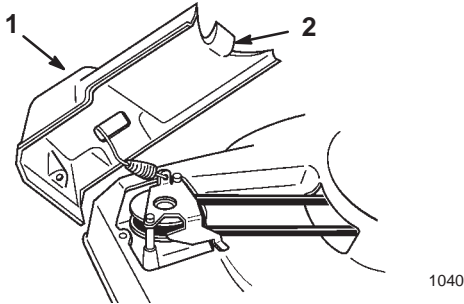

Figure 21

1. Belt cover
2. Tab

2. Tilt the cover up to the side and remove debris from under the cover and pulley groove (Fig. 21).
3. Reverse the procedure to install belt cover.

Maintaining the Cutting Blade

A straight, sharp blade provides maximum cutting performance. Inspect and sharpen or replace the blade every 50 operating hours (more frequently if the blade edge dulls quickly in rough or in sandy conditions).

! **Warning** !

The blade is sharp; contacting the blade can result in serious personal injury.

Wear gloves or wrap the sharp edges of the blade with a rag.

1. Disconnect the wire from the spark plug (Fig. 8).
2. Tip the lawn mower onto its **right** side (air filter up) (Fig. 18).

Inspecting the Blade

Carefully examine the blade for sharpness and wear, especially where the flat and the curved parts meet (Fig. 22A). Because sand and abrasive material can wear away the metal that connects the flat and curved parts of the blade, check the blade before using the lawn mower. If you notice a slot or wear (Figs. 22B and 22C), replace the blade; refer to Removing the Blade on page 16.

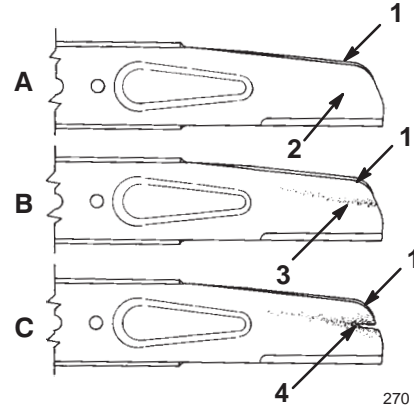

Figure 22

1. Sail
2. Flat part of blade
3. Wear
4. Slot formed

Note: For the best performance, install a new blade before the cutting season begins. During the year, file down any small nicks to maintain the cutting edge.

! **Danger** !

A worn or damaged blade can break, and a piece of the blade could be thrown into the operator's or bystander's area, resulting in serious personal injury or death.

- Inspect the blade periodically for wear or damage.
- Replace a worn or damaged blade.

Removing the Blade

1. Remove the blade nut (Fig. 23).

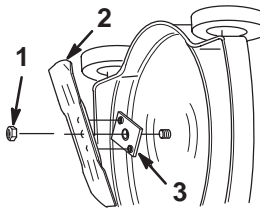

m-2909

Figure 23

- | | |
|--------------|-----------------|
| 1. Blade nut | 3. Blade driver |
| 2. Blade | |

2. Remove the blade from the blade driver (Fig. 23).

3. Examine the blade driver for bent or sheared drive lugs. Replace it if necessary.

Sharpening the Blade

File the top side of the blade to maintain its original cutting angle (Fig. 24A) and inner cutting edge radius (Fig. 24B). The blade will remain balanced if you remove the same amount of material from both cutting edges.

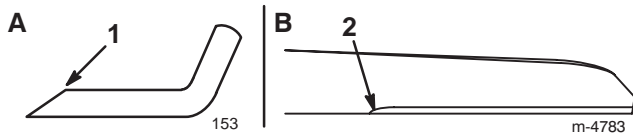
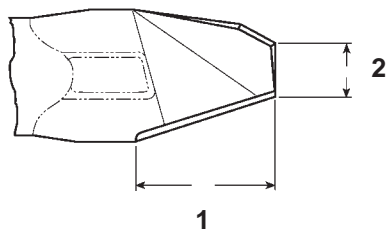

Figure 24

- | | |
|-------------------------------|--------------------------------------|
| 1. Sharpen at this angle only | 2. Maintain the original radius here |
|-------------------------------|--------------------------------------|

Note: Do not file or grind the blade more than 5 in. (127 mm) from the outside ends and no less than 2 in. (51 mm) from the trailing edge as shown in Figure 25.



990

Figure 25

- | | |
|--------------------|-------------------|
| 1. 5 in. (12.7 cm) | 2. 2 in. (5.1 cm) |
|--------------------|-------------------|

Balancing the Blade

1. Check the balance of the blade by placing the center hole of the blade over a nail or a screwdriver shank clamped horizontally in a vise (Fig. 26).

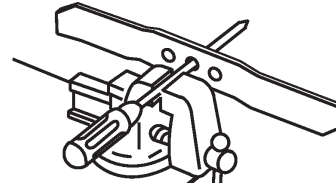

1007

Figure 26

Note: You can also check the balance by using a commercially manufactured blade balancer.

2. If either end of the blade rotates downward, file that end (not the cutting edge or the end near the cutting edge). The blade is properly balanced when neither end drops.

Installing the Blade

1. Ensure that the blade driver is installed on the crankshaft. See Figure 23.
2. Install the blade over the lugs of the blade driver with the curved ends toward the housing (Fig. 23).
3. Secure the blade with the blade nut as shown in Figure 27.

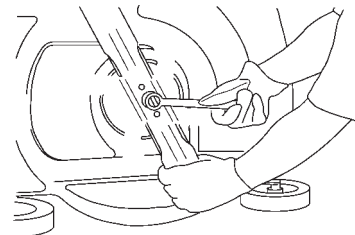

Figure 27

4. Torque the blade nut to 47 ft-lb (63 N·m).

Note: Replace the blade nut after installing and removing the blade four times. The locking power of the blade nut diminishes and the blade nut could loosen if you do not replace it.

5. Connect the wire to the spark plug.

Adjusting the Self-propel Drive Cable

Whenever you change the handle height, install a new self-propel drive cable, or if the traction drive belt slips, adjust the self-propel drive cable.

1. Loosen the nut on the cable support (Fig. 28).

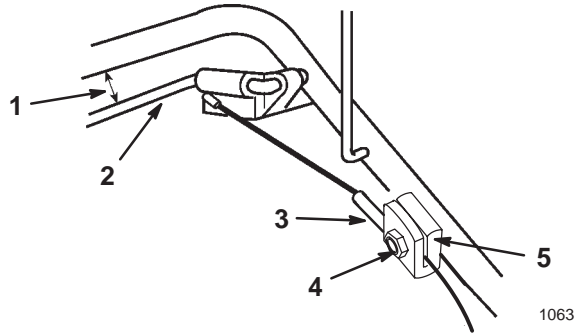

Figure 28

- | | |
|------------------------------|------------------|
| 1. 1 to 1½ in. (25 to 38 mm) | 4. Nut |
| 2. Self-propel drive bail | 5. Cable support |
| 3. Cable jacket | |

2. Hold the self-propel bail 1 to 1½ in. (25 to 38 mm) from the handle (Fig. 28).
3. Pull the cable jacket down (away from bail) to remove the slack in the cable between the bail and the cable support.
4. Tighten the nut on the cable support.
5. Release the bail and ensure that the cable is loose.

Note: The cable must be loose with the bail in the released position. Otherwise, the lawn mower may creep forward when you disengage the bail.

Lubricating the Self-propel Drive

Grease the fittings on the rear wheel height adjustment levers every 25 operating hours.

1. Wipe the grease fittings on the rear wheel height adjustment levers with a clean rag (Fig. 29).

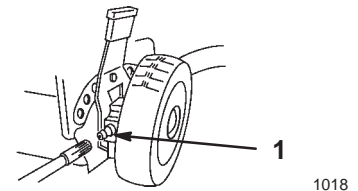

Figure 29

1. Grease fittings

2. Install a grease gun onto each fitting in turn and gently apply one or two pumps of #2 multi-purpose lithium grease to each.

Important Excess grease may prevent the wheel clutch from properly operating.

Maintaining the Spark Plug

A spark plug that is dirty, pitted, carbon-covered, or has worn electrodes may cause hard starting and poor operation.

Replace the spark plug once a season or clean it every 100 hours, whichever occurs first. Use a **Champion RJ19LM** spark plug or equivalent.

1. Stop the engine and wait for all moving parts to stop.
2. Disconnect the wire from the spark plug (Fig. 8).
3. Clean around the spark plug.
4. Remove the spark plug from the cylinder head.

Important Replace the spark plug if it is cracked, fouled, dirty, or if the electrodes are worn or damaged. Do not clean the electrodes because grit entering the cylinder can damage the engine.

5. Set the gap on the plug at 0.030 inch (0.76 mm) (Fig. 30).

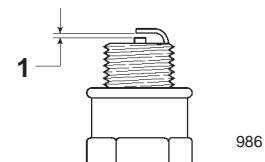

Figure 30

1. 0.030 in. (0.76 mm)

6. Install the spark plug by hand; then torque it to 180 in-lb (15 ft-lb or 20 N·m).

7. Connect the wire to the spark plug.

Changing the Fuse

Refer to Installing the Fuse on page 7.

Charging the Battery

Electric Start Model only

Warning

Battery posts, terminals, and related accessories contain lead and lead compounds, chemicals known to the State of California to cause cancer and reproductive harm. Wash hands after handling.

Charge a new or stored battery for 24 continuous hours to ensure a full charge. Charge the battery for 24 hours every month (every 25 starts) or as needed.

1. Stop the engine and wait for all moving parts to stop.
2. Disconnect the wire from the spark plug (Fig. 8).
3. Remove the key from the switch.
4. Connect the lead of the battery charger (supplied with your lawn mower) to the wire harness lead.

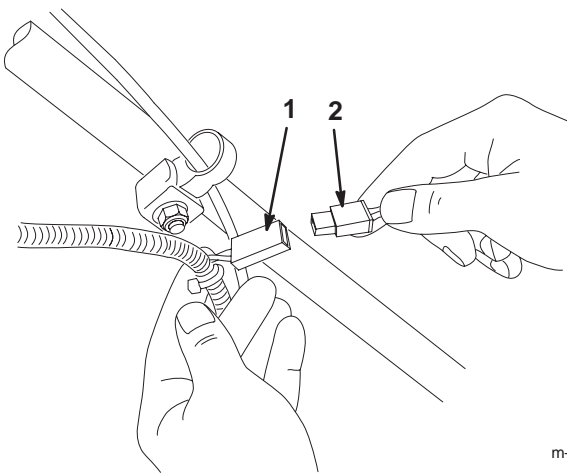

Figure 31

1. Wire harness lead
2. Battery charger lead

5. Plug the charger into a 120 VAC power outlet.
6. Charge the battery for the specified time.
7. Unplug the battery charger.

Important Use only the Lawn-Boy charger; other chargers could damage the battery. Always use the charger indoors and charge the battery at room temperature (70°F or 22°C) whenever possible.

8. Connect the wire to the spark plug.

Disposing of the Battery

Important Do not dispose of used batteries in your regular trash.

Important Recycle or dispose of a sealed lead (acid) battery according to local codes.

Incinerating, landfilling, or mixing of sealed lead (acid) batteries with the municipal solid waste stream is **prohibited by law** in most areas.

Return this battery to a federal- or state-approved sealed lead (acid) battery recycler.

Contact your local waste management officials for more information regarding the environmentally sound collection, recycling, and disposal of the battery.

Emptying the Fuel Tank

1. Stop the engine and wait for it to cool down.
2. Disconnect the wire from the spark plug (Fig. 8).
3. Remove the cap from the fuel tank (Fig. 9).
4. Use a hand pump to syphon the fuel into a clean approved gasoline container.
5. Connect the wire to the spark plug.
6. Run the engine until it stops.
7. Start the engine again to make sure that all the gasoline is out of the carburetor.

Storage

To prepare the lawn mower for off-season storage, perform the recommended maintenance procedures. Refer to Maintenance on page 12.

Store the lawn mower in a cool, dry place. Cover the lawn mower to keep it clean and protected.

Preparing the Fuel System

Warning

Gasoline can vaporize if you store it over long periods of time and explode if it comes into contact with an open flame.

- **Do not store gasoline over long periods of time.**
- **Do not store the lawn mower with gasoline in the fuel tank or the carburetor in an enclosure with an open flame. (For example, a furnace or a water heater pilot light.)**
- **Allow the engine to cool before storing it in any enclosure.**

1. Run the lawn mower until the engine stops from running out of fuel.
2. Prime the engine and start it again.
3. Allow the engine to run until it stops. When you can no longer start the engine, it is sufficiently dry.

Preparing the Engine

1. Remove the spark plug.
2. Using an oil can, add about one tablespoon of oil through the spark plug hole (Fig. 32).

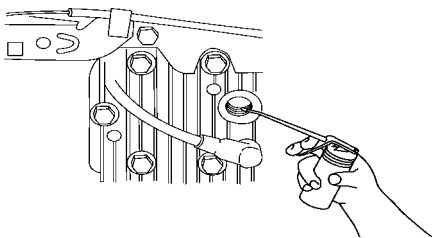

Figure 32

3. Slowly rotate the engine several times, using the starter rope, to distribute the oil (Fig. 10).
4. Install the spark plug but **do not** connect the wire to the spark plug.

General Information

1. Clean the lawn mower housing. Refer to Cleaning the Lawn Mower Housing on page 13.
2. Clean any dirt and chaff from the cylinder, cylinder head fins, and blower housing.
3. Remove grass clippings, dirt, and grime from the external parts of the engine, the shrouding, and the top of the lawn mower housing.
4. Check the condition of the blade. Refer to Maintaining the Cutting Blade on page 15.
5. Tighten all nuts, bolts, and screws.
6. Lubricate the wheels. Refer to Lubricating the Self-propel Drive on page 17.
7. Touch up all rusted or chipped paint surfaces with paint available from an Authorized Service Dealer.
8. Prepare the battery for storage (Electric Start Model only). Charge the battery for 72 hours to ensure a full charge (refer to Charging the Battery on page 18), then unplug the battery charger and store the lawn mower in an unheated area. If you must store the lawn mower in a heated area, you must charge the battery every 90 days.

Folding the Handle

Warning

Folding or unfolding the handle improperly can pinch, stretch, or damage one or more of the cables. Any pinched, stretched, or damaged cable may cause an operational failure that results in an unsafe operating condition.

- **Do not pinch, stretch, or damage the cables.**
- **Handle the cables with care when folding or unfolding the handle.**
- **Do not use the lawn mower if one or more of the cables are pinched, stretched, or damaged. Contact your Authorized Service Dealer.**

1. Squeeze the bottom handle sections together and slide them past the stops on the handle brackets (Fig. 33).

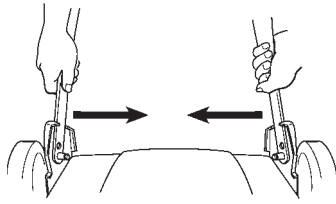

1039

Figure 33

2. Rotate the handle toward the front of the lawn mower (Fig. 34).

Important Fold the handle only as illustrated in Figure 34. If you fold the handle in the opposite direction, you will damage the control cables.

3. Loosen the knobs that secure the top handle section to the bottom section and fold the top handle section back toward the rear of the lawn mower into the storage position (Fig. 34).

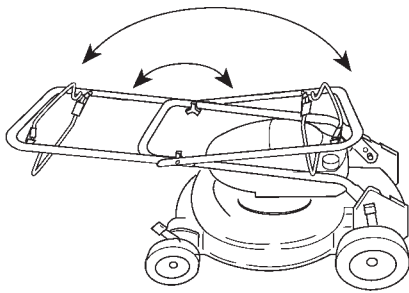

1068

Figure 34

Removing from Storage

1. Carefully unfold the handle. Refer to Unfolding the Handle on page 6.
2. Check and tighten all fasteners.
3. Remove the spark plug (Fig. 8) and spin the engine rapidly using the starter to blow excess oil from the cylinder.
4. Clean the spark plug or replace it if it is cracked, broken, or the electrodes are worn.
5. Install the spark plug and torque it to 180 in-lb (15 ft-lb or 20 N·m).
6. Perform the recommended maintenance procedures. Refer to Maintenance on page 12.

7. Fill the fuel tank (Fig. 9) with fresh, clean gasoline.
8. Check the engine oil level.
9. Connect the wire to the spark plug (Fig. 8).
10. Charge the battery (Electric Start Model only). Refer to Charging the Battery on page 18.

Accessories

Your lawn mower may include the following accessories available from your Authorized Service Dealer:

- Side Grass Catcher Kit
- Rear Grass Catcher Kit

For proper installation of the rear grass catcher, follow these instructions.

Installing the Rear Grass Catcher

1. Stop the engine and disconnect the spark plug wire (Fig. 8).
2. Remove the wing screw that fastens the cover plate to the housing (Fig. 35).

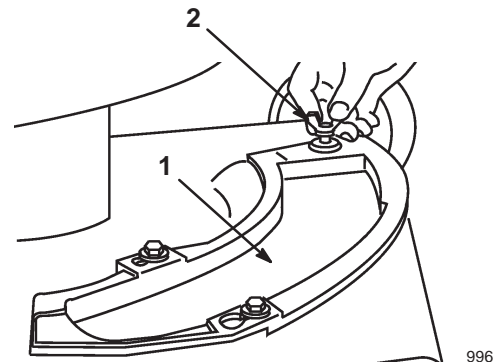

996

Figure 35

1. Cover or mulch plate
 2. Wing screw
3. Slide the cover plate counterclockwise and remove it from the lawn mower housing.
 4. Place front corner of the chute baffle into the deck opening. Rotate the chute counterclockwise and push down into the deck opening (Fig. 36).

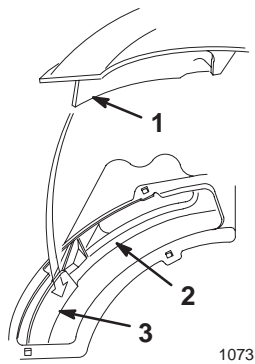

Figure 36

- 1. Chute baffle
- 2. Toe guard
- 3. Deck baffle

Note: The chute baffle must go behind the front deck baffle and between the blade and toe guard to prevent contact with the blade.

5. Insert the chute support rod through hole in the right side of the deck (Fig. 37).

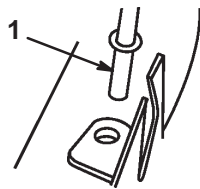

Figure 37

- 1. Chute support rod

6. Push the keyhole slots on the chute down over the two shoulder bolts on the lawn mower housing and slide the chute clockwise to lock it in place (Fig. 38).

7. Secure with the wing screw (Fig. 38).

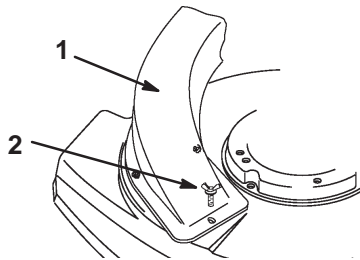

Figure 38

- 1. Chute assembly
- 2. Wing screw

8. Check the clearance between blade tips and the baffle, ensuring that there is no contact (Fig. 39).

Note: The baffle must go behind the front deck baffle and between the blade and toe guard to prevent contact with the blade (Fig. 39).

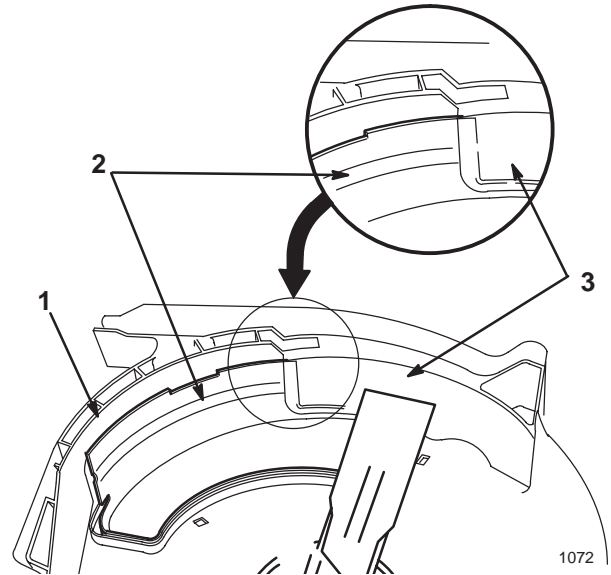

Figure 39

- 1. Toe guard
- 2. Baffle
- 3. Front deck baffle

9. Remove the knob and bolt that secure the left side upper and lower handle sections (Fig. 40).

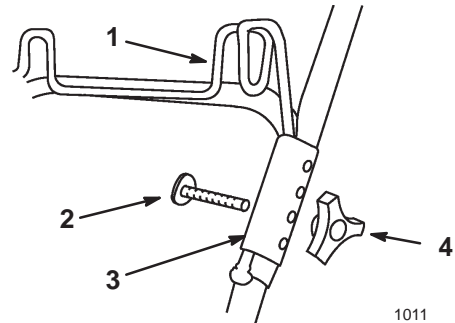

Figure 40

- 1. Bag hanger
- 2. Bolt
- 3. Hanger clamp
- 4. Knob

10. Hold a hanger clamp on the outside of the handle sections, and insert a bolt from the inside of the handle sections through the holes in the hanger clamp.

11. Position the bag hanger leg into the hanger clamp groove and secure it with a knob.

12. Repeat steps 9 through 11 for the other side.

13. Close the rear of the bag by folding the sides in and pressing the interlocking rear handle halves together (Fig. 41).

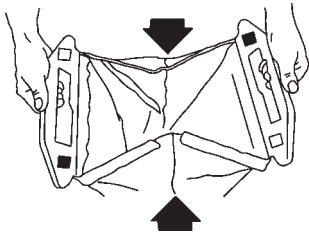

Figure 41

1012

14. Hang the rear bag handles on the bag hanger on the handle.
15. Grasp the bag assembly handle and slide it over the flange of the grass chute (Fig. 42). Push downward on the handle until it seats into position.

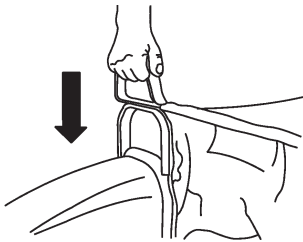

Figure 42

1010

16. Ensure that the bag is taut on the top cloth area between the front bag handle and the rear bag hanger handles. If the bag is too tight or too loose, adjust it as follows:
- Remove the bag from the rear bag hanger.
 - Remove the bolts and knobs securing the hanger clamps to the handle sections (Fig. 40).
 - Assemble the hanger clamps on the handle sections, using the set of holes best holds the bag taut.

Note: Using the lower holes tightens the bag assembly; using the upper holes loosens the assembly.

17. Connect the spark plug wire.

Note: Under normal use, bag materials are subject to deterioration and wear. Check the grass bag often and replace the when necessary with a genuine Lawn-Boy replacement bag. A weakened or inferior bag may let objects pass through, causing injury.

Installing the Cover Plate

To convert from mulching to side discharging, remove the mulch plate and install a cover plate.



Warning



An uncovered discharge opening could allow the lawn mower to throw objects in the operator's or bystander's direction and result in serious injury. Also, contact with the blade could occur.

Never operate the lawn mower unless you install a cover plate, a mulch plate, or a grass chute and catcher.

- Stop the engine and wait for all moving parts to stop.
- Disconnect the wire from the spark plug (Fig. 8).
- Remove the wing screw that fastens the mulch plate to the housing (Fig. 35).
- Slide the mulch plate counterclockwise and remove it the lawn mower housing.
- Slide the cover plate over the shoulder bolts (Fig. 43).

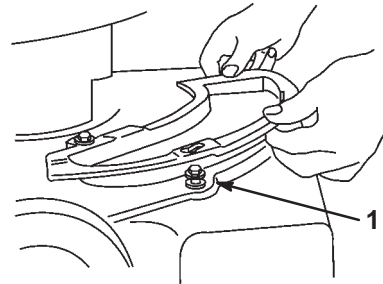

995

Figure 43

- Shoulder bolt
- Slide the cover plate clockwise.
- Secure the cover plate with the wing screw.
- Connect the wire to the spark plug (Fig. 8).

Installing the Mulch Plate

To convert from side discharging to mulching, remove the cover plate and install the mulch plate.

Note: Use only a genuine Lawn-Boy replacement cutting blade. Other blades may strike the mulch plate when you start and run the engine.

Warning

An uncovered discharge opening could allow the lawn mower to throw objects in the operator's or bystander's direction and result in serious injury. Also, contact with the blade could occur.

Never operate the lawn mower unless you install a cover plate, a mulch plate, or a grass chute and catcher.

1. Stop the engine and wait for all moving parts to stop.
2. Disconnect the wire from the spark plug (Fig. 8).
3. Remove the wing screw that fastens the cover plate to the housing (Fig. 35).
4. Slide the cover plate counter clockwise and remove it from the lawn mower housing.
5. Place the front corner of the mulch plate baffle into the deck opening (Fig. 36).
6. Rotate the mulch plate counterclockwise and push it down into the deck opening (Fig. 36).

Note: The mulch plate baffle must go behind the front deck baffle and between the blade and toe guard to prevent it from contacting the blade (Fig. 39).

7. Slide the mulch plate over the shoulder bolts (Fig. 44).

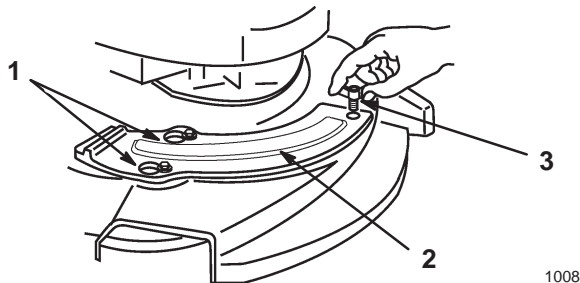

Figure 44

- | | |
|-------------------|---------------|
| 1. Shoulder bolts | 3. Wing screw |
| 2. Mulch plate | |

8. Slide the mulch plate clockwise.
9. Secure the mulch plate with the wing screw (Fig. 44).
10. Check the clearance between the blade tips and the baffle, ensuring that there is no contact (Fig. 39).
11. Connect the wire to the spark plug.

Troubleshooting

Lawn-Boy designed and built your lawn mower for trouble-free operation. Check the following components and items carefully, and refer to Maintenance on page 12 for more information. If a problem continues, contact an Authorized Service Dealer.

Problem	Possible Causes	Corrective Action
Engine does not start	<ol style="list-style-type: none"> 1. The fuel tank is empty or the fuel system contains stale fuel. 2. The primer has not been pushed in. 3. The wire is not connected to the spark plug. 4. The spark plug is pitted, fouled, or the gap is incorrect. 	<ol style="list-style-type: none"> 1. Drain and/or fill the fuel tank with fresh gasoline. If the problem persists, contact an Authorized Service Dealer. 2. Push the primer in 3 times. 3. Connect the wire to the spark plug. 4. Check the spark plug and adjust the gap if necessary. Replace the spark plug if it is pitted, fouled, or cracked.
Engine starts hard or loses power	<ol style="list-style-type: none"> 1. The fuel tank contains stale fuel. 2. The fuel cap vent hole is plugged. 3. The air filter element is dirty and is restricting the air flow. 4. The underside of the lawn mower deck contains clippings and debris. 5. The spark plug is pitted, fouled, or the gap is incorrect. 6. The engine oil level is low or the oil is dirty. 	<ol style="list-style-type: none"> 1. Drain and fill the fuel tank with fresh gasoline. 2. Clean the fuel cap vent hole or replace the fuel cap. 3. Clean the air filter pre-cleaner and/or replace the paper air filter. 4. Clean the underside of the lawn mower deck. 5. Check the spark plug and adjust the gap if necessary. Replace the spark plug if it is pitted, fouled, or cracked. 6. Check the engine oil. Change the oil if it is dirty or add oil if it is low.
Engine runs rough	<ol style="list-style-type: none"> 1. The wire is not connected to the spark plug. 2. The spark plug is pitted, fouled, or the gap is incorrect. 3. The air filter element is dirty and is restricting the air flow. 	<ol style="list-style-type: none"> 1. Connect the wire to the spark plug. 2. Check the spark plug and adjust the gap if necessary. Replace the spark plug if it is pitted, fouled, or cracked. 3. Clean the air filter pre-cleaner and/or replace the paper air filter.

Problem	Possible Causes	Corrective Action
Lawn mower or engine vibrates excessively	<ol style="list-style-type: none"> 1. The blade is bent or is out of balance. 2. The blade bolt is loose. 3. The underside of the lawn mower deck contains clippings and debris. 4. The engine mounting bolts are loose. 	<ol style="list-style-type: none"> 1. Balance the blade. If the blade is bent, replace it. 2. Tighten the blade bolt. 3. Clean the underside of the lawn mower deck. 4. Tighten the engine mounting bolts.
Uneven cutting pattern	<ol style="list-style-type: none"> 1. All 4 wheels are not at the same height. 2. The blade is dull. 3. You are mowing in the same pattern repeatedly. 4. The underside of the lawn mower deck contains clippings and debris. 	<ol style="list-style-type: none"> 1. Place all 4 wheels at the same height. 2. Sharpen and balance the blade. 3. Change the mowing pattern. 4. Clean the underside of the lawn mower deck.
Discharge chute plugs	<ol style="list-style-type: none"> 1. The cutting height is too low. 2. You are mowing too fast. 3. The grass is wet. 4. The underside of the lawn mower deck contains clippings and debris. 	<ol style="list-style-type: none"> 1. Raise the cutting height. 2. Slow down. 3. Allow the grass to dry before mowing. 4. Clean the underside of the lawn mower deck.
Lawn mower does not self-propel	<ol style="list-style-type: none"> 1. The self-propel drive cable is out of adjustment or is damaged. 2. There is debris under the belt cover. 	<ol style="list-style-type: none"> 1. Adjust the self-propel drive cable. Replace the cable if necessary. 2. Clean the debris from under the belt cover.



Silver Series WPM
 SilverPro Series WPM
 Commercial WPM

The Lawn-Boy No-Worry Warranty

A Two-Year Full Warranty
 (Limited Warranty for Commercial Use)

Conditions and Products Covered

For a period of two years from the date of purchase, Lawn-Boy and its affiliate, Lawn-Boy Warranty Company, pursuant to an agreement between them, jointly promise to repair any Lawn-Boy Product used for normal residential purposes* if defective in materials or workmanship or if it stops functioning due to the failure of a component. The following time periods apply from the date of purchase:

<u>Products</u>	<u>Warranty Period</u>
• All Mowers	2 year full warranty
• All Batteries	1 year full warranty

This warranty covers the cost of parts and labor, but you must pay transportation costs.

This warranty applies to all Silver Series, SilverPro Series, and Commercial Series Walk Power Mowers.

* Normal residential purposes means use of the product on the same lot as your home. Use at more than one location is considered commercial use, and the commercial use warranty would apply.

Limited Warranty for Commercial Use

Lawn-Boy Walk Power Mowers used for commercial, institutional, or rental use are warranted against defects in materials or workmanship. Components failing due to normal wear are not covered by this warranty. The following time periods apply from the date of purchase:

<u>Products</u>	<u>Warranty Period</u>
• Commercial Series Mowers	1 year
• All Other Lawn-Boy Mowers	45 days

Instructions for Obtaining Warranty Service

Should you feel your Lawn-Boy Product contains a defect in materials or workmanship, contact the dealer who sold you the product or any Authorized Service Dealer or Master Service Dealer. The Yellow Pages of your telephone directory is a good reference source. The dealer will either arrange service at his/her dealership or recommend another Authorized Service Dealer who may be more convenient. You may need proof of purchase (copy of registration card, sales receipt, etc.) for warranty validation.

If for any reason you are dissatisfied with the Service Dealer's analysis of the defect in materials or workmanship or if you need a referral to a Lawn-Boy Service Dealer, please feel free to contact us at:

Customer Service Department
 Lawn-Boy Warranty Company
 8111 Lyndale Avenue South
 Bloomington, MN 55420-1196
 952-888-8801 or 800-LB-MOWER (800-526-6937)

Countries Other than the United States or Canada

Customers who have purchased Lawn-Boy products exported from the United States or Canada should contact their Lawn-Boy Distributor (Dealer) to obtain guarantee policies for your country, province, or state. If for any reason you are dissatisfied with your Distributor's service or have difficulty obtaining guarantee information, contact the Lawn-Boy importer. If all other remedies fail, you may contact us at Lawn-Boy Warranty Company.

Owner Responsibilities

You must maintain your Lawn-Boy Product by following the maintenance procedures described in the operator's manual. Such routine maintenance, whether performed by a dealer or by you, is at your expense.

Items and Conditions Not Covered

There is no other express warranty except for special emission system coverage on some products. This express warranty does not cover:

- Cost of regular maintenance service or parts, such as filters, fuel, lubricants, oil changes, spark plugs, blade sharpening, worn blade, cable/linkage adjustments, or brake and clutch adjustments.
- Any product or part which has been altered or misused or required replacement or repair due to accidents or lack of proper maintenance.
- Repairs necessary due to improper fuel, contaminants in the fuel system, or failure to properly prepare the fuel system prior to any period of non-use over three months.
- Repairs necessary due to improper battery care, electrical supply irregularities, or failure to properly prepare the mower prior to any period of non-use.
- Pickup and delivery charges.

All repairs covered by this warranty must be performed by an Authorized Lawn-Boy Service Dealer using Lawn-Boy approved replacement parts.

General Conditions

Repair by an Authorized Lawn-Boy Service Dealer is your sole remedy under this warranty.

Neither Lawn-Boy or Lawn-Boy Warranty Company is liable for indirect, incidental or consequential damages in connection with the use of the Lawn-Boy Products covered by this warranty, including any cost or expense of providing substitute equipment or service during reasonable periods of malfunction or non-use pending completion of repairs under this warranty.

Some states do not allow exclusions of incidental or consequential damages, or limitations on how long an implied warranty lasts, so the above exclusions and limitations may not apply to you.

This warranty gives you specific legal rights, and you may also have other rights which vary from state to state.